

PowerScan[®] PD8530



Reference Manual

Datalogic Scanning, Inc.
959 Terry Street
Eugene, Oregon 97402
Telephone: (541) 683-5700
Fax: (541) 345-7140

An Unpublished Work - All rights reserved. No part of the contents of this documentation or the procedures described therein may be reproduced or transmitted in any form or by any means without prior written permission of Datalogic Scanning, Inc. or its subsidiaries or affiliates ("Datalogic" or "Datalogic Scanning"). Owners of Datalogic products are hereby granted a non-exclusive, revocable license to reproduce and transmit this documentation for the purchaser's own internal business purposes. Purchaser shall not remove or alter any proprietary notices, including copyright notices, contained in this documentation and shall ensure that all notices appear on any reproductions of the documentation.

Should future revisions of this manual be published, you can acquire printed versions by contacting your Datalogic representative. Electronic versions may either be downloadable from the Datalogic website (www.scanning.datalogic.com) or provided on appropriate media. If you visit our website and would like to make comments or suggestions about this or other Datalogic publications, please let us know via the "Contact Datalogic" page.

DISCLAIMER

Datalogic has taken reasonable measures to provide information in this manual that is complete and accurate, however, Datalogic reserves the right to change any specification at any time without prior notice. Datalogic is a registered trademark of Datalogic S.p.A. in many countries and the Datalogic logo is a trademark of Datalogic S.p.A. all licensed to Datalogic Scanning, Inc. All other trademarks and trade names referred to herein are property of their respective owners.

CONTENTS

GENERAL VIEW	v
COMPLIANCE	v
CE Compliance	vi
FCC Compliance	vi
Laser Safety	vi
WEEE Compliance	x
Power Supply	xi
PATENTS	xi
SERVICE AND SUPPORT	xii
1 INTRODUCTION	1
1.1 PowerScan® PD8530 Family Description	1
1.2 Package Contents	1
1.3 Configuration Methods	2
1.3.1 Reading Configuration Codes	2
1.3.2 Using Datalogic Aladdin™	2
1.3.3 Sending Configuration Strings from Host	2
1.4 CABLE CONNECTION	3
2 USING POWERSCAN® PD8530	5
2.1 Aiming System	5
2.2 Normal Operation	6
2.3 Image Capturing	6
2.3.1 Basic Configuration Parameters	7
2.3.2 Advanced Configuration Parameters	8
2.4 Autoscanning	8
2.4.1 Normal Mode	8
2.4.2 Pattern Mode	8
2.5 Camera Control	9
2.6 Defining Data Formatting	10
2.6.1 Concatenation	11

3	INITIAL SETUP	12
3.1	RS-232 Interface Selection	12
3.2	Wedge Interface Selection	13
3.3	USB Interface Selection	14
3.4	IBM USB	17
4	CONFIGURATION USING CODE SYMBOLS	18
4.1	Default Settings	19
4.2	Changing Default Settings	24
4.3	Advanced Data Format	89
4.3.1	Format Definition	90
4.3.2	Match Conditions	107
4.3.3	Format Enable/Disable	109
4.3.4	Mismatch Result	110
5	REFERENCES	111
5.1	RS-232 – USB COM	111
5.1.1	ACK/NACK Protocol	111
5.1.2	RX Timeout	111
5.2	USB Keyboard	112
5.2.1	Keyboard Speed	112
5.3	Code Selection	112
5.3.1	Issue Identical Codes	112
5.4	Reading Parameters	112
5.4.1	Safety Time	112
5.5	Configuration Editing Commands	113
6	TEST CODE SYMBOLS	114
7	MAINTENANCE	116
8	TECHNICAL FEATURES	117
8.1	Indicators	121
8.1.1	PowerScan® PD8530 LED Indicators	121
8.1.2	Beeper	121
8.1.3	Good Read Spot	121
	Function Description	134

GENERAL VIEW



POWERSCAN® PD8530 Reader

COMPLIANCE

	<p>Aiming System Imager Beam Output Window</p>
<div style="border: 1px solid black; padding: 10px;"> <p style="text-align: center; font-size: small;">DO NOT STARE INTO BEAM</p> <div style="display: flex; justify-content: space-between;"> <div style="text-align: center;"> <p style="font-size: x-small;">This product complies with 21 CFR Subchapter J</p> </div> <div style="border: 1px solid black; padding: 2px; font-size: x-small;"> <p style="text-align: center; margin: 0;">LASER LIGHT - DO NOT STARE INTO BEAM! CLASS 2 LASER PRODUCT MAX. OUTPUT POWER: 5 mW EMITTED WAVELENGTH: 630-680 nm EN60929-7-2007</p> </div> <div style="text-align: center;"> <p style="font-size: x-small;">CAUTION-CLASS 2 LASER LIGHT RAYS CAN CAUSE EYE HARM AVOID EXPOSURE - LASER LIGHT IS EMITTED FROM THIS APPLIANCE CLASS 1 LED PRODUCT</p> </div> </div> <p style="text-align: center; font-size: x-small;">See Pkg for patent listing</p> <div style="border: 1px solid black; padding: 2px; font-size: x-small;"> <p style="margin: 0;">DataLogic Scanning Inc. Model: POWERSCAN D8530 Eugene, Oregon USA Made in Slovak Republic</p> <div style="display: flex; justify-content: space-between;"> </div> <p style="font-size: x-small;">MFG DATE: January 2008 Serial No: E08P00000</p> </div> <p style="font-size: x-small;">This device complies with Part 15 of the FCC Rules. Operation is subject to the following two conditions: (1) this device may not cause harmful interference, and (2) this device must accept any interference received, including interference that may cause undesired operation.</p> <div style="display: flex; justify-content: space-between; align-items: center;"> <div style="text-align: center;"> </div> <div style="text-align: center;"> </div> <div style="text-align: center;"> <p style="font-size: x-small;">239045</p> </div> </div> </div>	

POWERSCAN® PD8530 Reader Product Labels

CE COMPLIANCE



WARNING

This is a Class A product . In a domestic environment this product may cause radio interference, in which case the user may be required to take adequate measures.

FCC COMPLIANCE

Modifications or changes to this equipment without the expressed written approval of Datalogic could void the authority to use this equipment.

This device complies with Part 15 of the FCC Rules. Operation is subject to the following two conditions: (1) This device may not cause harmful interference, and (2) this device must accept any interference received, including interference which may cause undesired operation.

This equipment has been tested and found to comply with the limits for a Class A digital device, pursuant to part 15 of the FCC Rules. These limits are designed to provide reasonable protection against harmful interference when the equipment is operated in a commercial environment. This equipment generates, uses, and can radiate radio frequency energy and, if not installed and used in accordance with the instruction manual, may cause harmful interference to radio communications. Operation of this equipment in a residential area is likely to cause harmful interference in which case the user will be required to correct the interference at his own expense.

LASER SAFETY

The PowerScan® PD8530 hand-held reader is a Class 1 LED product regarding its Illuminator and a Class 2 laser product regarding its Aiming System.

LED Illuminator

The use of an illuminator in the PowerScan® PD8530 Family is a Class 1 LED product:

ILLUMINATORE LED CLASSE 1
AUSLEUCHTER LED KLASSE 1
ILLUMINATEUR A LED DE CLASSE 1
ILUMINADOR LED DE CLASE 1

Aiming System

The PowerScan® PD8530 aiming system meets the requirements for laser safety.

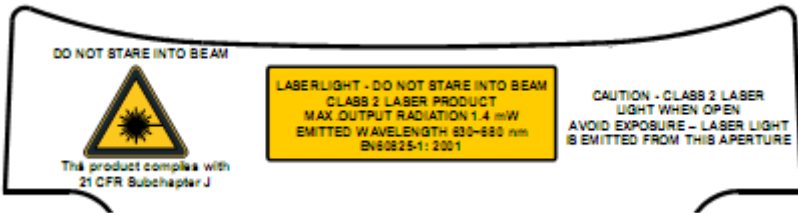

I	D	F	E
LA LUCE LASER È VISIBILE ALL'OCCHIO UMANO E VIENE EMESSA DALLA FINESTRA INDICATA NELLA FIGURA.	DIE LASER-STRAHLUNG IST FÜR DAS MENSCHLICHE AUGE SICHTBAR UND WIRD AM STRAHLAUS-TRITTSFENSTER AUSGESENDET (SIEHE BILD)	LE RAYON LASER EST VISIBLE À L'OEUIL NU ET IL EST ÉMIS PAR LA FENÊTRE DÉSIGNÉE SUR L'ILLUSTRATION DANS LA FIGURE	LA LUZ LÁSER ES VISIBILE AL OJO HUMANO Y ES EMITIDA POR LA VENTANA INDICADA EN LA FIGURA.
LUCE LASER NON FISSARE IL FASCIO APPARECCHIO LASER DI CLASSE 2 MASSIMA POTENZA D'USCITA: LUNGHEZZA D'ONDA EMESSA: CONFORME A EN 60825-1 (2001)	LASERSTRAHLUNG NICHT IN DEN STRAHL BLICKEN PRODUKT DER LASERKLASSE 2 MAXIMALE AUSGANGSLEISTUNG: WELLENLÄGE: ENTSPR. EN 60825-1 (2001)	RAYON LASER EVITER DE REGARDER LE RAYON APPAREIL LASER DE CLASSE 2 PUISSANCE DE SORTIE: LONGUEUR D'ONDE EMISE: CONFORME A EN 60825-1 (2001)	RAYO LÁSER NO MIRAR FIJO EL RAYO APARATO LÁSER DE CLASE 2 MÁXIMA POTENCIA DE SALIDA: LONGITUD DE ONDA EMITIDA: CONFORME A EN 60825-1 (2001)

ENGLISH

The following information is provided to comply with the rules imposed by international authorities and refers to the correct use of your terminal.

STANDARD LASER SAFETY REGULATIONS

This product conforms to the applicable requirements of both CDRH 21 CFR 1040 and EN 60825-1 at the date of manufacture.

For installation, use and maintenance, it is not necessary to open the device.



WARNING *Use of controls or adjustments or performance of procedures other than those specified herein may result in exposure to hazardous visible laser light.*

The product utilizes a low-power laser diode. Although staring directly at the laser beam momentarily causes no known biological damage, avoid staring at the beam as one would with any very strong light source, such as the sun. Avoid allowing the laser beam to hit the eye of an observer, even through reflective surfaces such as mirrors, etc.

ITALIANO

Le seguenti informazioni vengono fornite dietro direttive delle autorità internazionali e si riferiscono all'uso corretto del terminale.

NORMATIVE STANDARD PER LA SICUREZZA LASER

Questo prodotto risulta conforme alle normative vigenti sulla sicurezza laser alla data di produzione: CDRH 21 CFR 1040 e EN 60825-1.

Non si rende mai necessario aprire l'appa-recchio per motivi di installazione, utilizzo o manutenzione.



ATTENZIONE

L'utilizzo di procedure o regolazioni differenti da quelle descritte nella documentazione può provocare un'esposizione pericolosa a luce laser visibile.

Il prodotto utilizza un diodo laser a bassa potenza. Sebbene non siano noti danni riportati dall'occhio umano in seguito ad una esposizione di breve durata, evitare di fissare il raggio laser così come si eviterebbe qualsiasi altra sorgente di luminosità intensa, ad esempio il sole. Evitare inoltre di dirigere il raggio laser negli occhi di un osservatore, anche attraverso superfici riflettenti come gli specchi.

DEUTSCH

Die folgenden Informationen stimmen mit den Sicherheitshinweisen überein, die von internationalen Behörden auferlegt wurden, und sie beziehen sich auf den korrekten Gebrauch vom Terminal.

NORM FÜR DIE LASERSICHERHEIT

Dies Produkt entspricht am Tag der Herstellung den gültigen EN 60825-1 und CDRH 21 CFR 1040 Normen für die Lasersicherheit.

Es ist nicht notwendig, das Gerät wegen Betrieb oder Installations-, und Wartungsarbeiten zu öffnen.



ACHTUNG

Jegliche Änderungen am Gerät sowie Vorgehensweisen, die nicht in dieser Betriebsanleitung beschrieben werden, können ein gefährliches Laserlicht verursachen.

Der Produkt benutzt eine Laserdiode. Obwohl zur Zeit keine Augenschäden von kurzen Einstrahlungen bekannt sind, sollten Sie es vermeiden für längere Zeit in den Laserstrahl zu schauen, genauso wenig wie in starke Lichtquellen (z.B. die Sonne). Vermeiden Sie es, den Laserstrahl weder gegen die Augen eines Beobachters, noch gegen reflektierende Oberflächen zu richten.

FRANÇAIS

Les informations suivantes sont fournies selon les règles fixées par les autorités internationales et se réfèrent à une correcte utilisation du terminal.

NORMES DE SECURITE LASER

Ce produit est conforme aux normes de sécurité laser en vigueur à sa date de fabrication: CDRH 21 CFR 1040 et EN 60825-1.

Il n'est pas nécessaire d'ouvrir l'appareil pour l'installation, l'utilisation ou l'entretien.



ATTENTION

L'utilisation de procédures ou réglages différents de ceux donnés ici peut entraîner une dangereuse exposition à lumière laser visible.

Le produit utilise une diode laser. Aucun dommage aux yeux humains n'a été constaté à la suite d'une exposition au rayon laser. Eviter de regarder fixement le rayon, comme toute autre source lumineuse intense telle que le soleil. Eviter aussi de diriger le rayon vers les yeux d'un observateur, même à travers des surfaces réfléchissantes (miroirs, par exemple).

ESPAÑOL

Las informaciones siguientes son presentadas en conformidad con las disposiciones de las autoridades internacionales y se refieren al uso correcto del terminal.

NORMATIVAS ESTÁNDAR PARA LA SEGURIDAD LÁSER

Este aparato resulta conforme a las normativas vigentes de seguridad láser a la fecha de producción: CDRH 21 CFR 1040 y EN 60825-1.

No es necesario abrir el aparato para la instalación, la utilización o la manutención.



ATENCIÓN

La utilización de procedimientos o regulaciones diferentes de aquellas descritas en la documentación puede causar una exposición peligrosa a la luz láser visible.

El aparato utiliza un diodo láser a baja potencia. No son notorios daños a los ojos humanos a consecuencia de una exposición de corta duración. Eviten de mirar fijo el rayo láser así como evitarían cualquiera otra fuente de luminosidad intensa, por ejemplo el sol. Además, eviten de dirigir el rayo láser hacia los ojos de un observador, también a través de superficies reflectantes como los espejos.



CAUTION

The POWERSCAN® PD8530 Hand-Held Reader is not user-serviceable. Opening the case of the unit can cause internal damage and will void the warranty.

WEEE COMPLIANCE



Waste Electrical and Electronic Equipment (WEEE) Statement

English

For information about the disposal of Waste Electrical and Electronic Equipment (WEEE), please refer to the website at www.scanning.datalogic.com.

Italian

Per informazioni sullo smaltimento delle apparecchiature elettriche ed elettroniche consultare il sito Web www.scanning.datalogic.com.

French

Pour toute information relative à l'élimination des déchets électroniques (WEEE), veuillez consulter le site Internet www.scanning.datalogic.com.

German

Informationen zur Entsorgung von Elektro- und Elektronik- Altgeräten (WEEE) erhalten Sie auf der Webseite www.scanning.datalogic.com.

Spanish

Si desea información acerca de los procedimientos para el desecho de los residuos del equipo eléctrico y electrónico (WEEE), visite la página Web www.scanning.datalogic.com.

Portuguese

Para informações sobre a disposição de Sucatagem de Equipamentos Eléctricos e Eletrônicos (WEEE - Waste Electrical and Electronic Equipment), consultar o site web www.scanning.datalogic.com.

Chinese

有关处理废弃电气电子设备 (WEEE) 的信息, 请参考Datalogic公司的网站:
<http://www.scanning.datalogic.com/>.

Japanese

廃電気電子機器(WEEE)の処理についての関連事項はDatalogicのサイト www.scanning.datalogic.com, をご参照下さい。

POWER SUPPLY

This device is intended to be supplied by a UL Listed or CSA Certified Power Unit marked "Class 2" or "LPS" output rated 5-30 V, minimum 0.75 A which supplies power directly to the scanner via the jack connector on the cable.

PATENTS

This product is covered by one or more of the following patents:

Design Pat.: AU 310201; AU 310202; CN 693980; HK 0602013.5M001; HK 0602013.5M002; JP 1305693; KR 30-0460940.

US Pat.: 6,478,226 B2; 6,512,218 B1; 6,808,114 B1; 6,877,664 B1; 6,997,385 B2; 7,053,954 B1; 7,102,116 B2; 7,282,688 B2.

European Pat.: 996,284 B1; 999,514 B1; 1,128,315 B1.

Additional patents pending.

SERVICE AND SUPPORT

Datalogic provides several services as well as technical support through its website. Log on to www.scanning.datalogic.com and click on the links indicated for further information including:

- **PRODUCTS**

Search through the links to arrive at your product page where you can download specific **Manuals** and **Software & Utilities** including:

- **Datalogic Aladdin™** a multi-platform utility program that allows device configuration using a PC. It provides RS-232 interface configuration as well as configuration barcode printing.

- **SERVICE & SUPPORT**

- **Technical Support** - Product documentation and programming guides and Technical Support Department in the world
- **Service Programs** - Warranty Extensions and Maintenance Agreements
- **Repair Services** - Flat Rate Repairs and Return Material Authorization (RMA) Repairs.
- **Downloads** – Manuals & Documentation, Data Sheets, Product Catalogues, etc.

- **CONTACT US**

Information Request Form and Sales & Service Network

1 INTRODUCTION

1.1 POWERSCAN® PD8530 FAMILY DESCRIPTION

The PowerScan® PD8530 Family Hand-Held Reader packs a lot of performance into an attractive, rugged, hand-held device. It operates in commercial and industrial environments as well as the front office.

Omni-directional Operating To read a symbol or capture an image, you simply aim the reader and pull the trigger. Since PowerScan® PD8530 Family is a powerful omni-directional reader, the orientation of the symbol is not important.

Decoding and Imaging Thanks to powerful algorithms, PowerScan® PD8530 reliably decodes all major 1D (linear) barcodes, 2D stacked codes (such as PDF417), 2D matrix symbols (such as DataMatrix), postal codes (such as POSTNET, PLANET). The data stream — acquired from decoding a symbol — is rapidly sent to the host. The reader is immediately available to read another symbol.

PowerScan® PD8530 can also function as a camera by capturing images of labels, signatures, and other items.

Flash Memory Flash technology allows to upgrade the PowerScan® PD8530 reader as new symbologies are supported or as improved decoding algorithms become available.

USA Driver License Parsing The PowerScan® PD8530 reader can be set up to select and output a subset of data elements from USA Driver License PDF417 barcodes. This feature can be enabled using either Datalogic Aladdin™ or the barcodes in the USA Driver License Parsing Quick Reference Guide (QRG), available on the Datalogic website.

1.2 PACKAGE CONTENTS

The following parts are included in the PowerScan® PD8530 package contents:

- PowerScan® PD8530 Hand-Held Reader
- CD-ROM containing the PowerScan® PD8530 Configuration Tools software and PowerScan® PD8530 Reference Manual
- PowerScan® PD8530 Quick Reference Manual

You may want to save your packing material in case you need to ship the reader at some later time.

1.3 CONFIGURATION METHODS

1.3.1 Reading Configuration Codes

This manual can be used for complete setup and configuration. If you wish to change the default settings, you can configure the PowerScan® PD8530 reader by reading the programming code symbols in this manual. Configuration commands and their relative arguments are read individually using the symbols in this manual. See Appendix D.

1.3.2 Using Datalogic Aladdin™

The Datalogic Aladdin™ program, available on the CD-ROM provided, allows programming the reader by selecting configuration commands or printing them through a user-friendly graphical interface running on the PC. These commands are sent to the reader over the current communication interface; or they can be printed to be read.

1.3.3 Sending Configuration Strings from Host

An alternative configuration method is provided in Appendix A using the RS-232 or USB COM interface. This method is particularly useful when many devices need to be configured with the same settings. Batch files containing the desired parameter settings can be prepared to configure devices quickly and easily.

The PowerScan® PD8330 reader incorporates a multi-standard interface, which can be connected to a Host by plugging the correct interface cable into the connector and closing the cable cover.

1.4 CABLE CONNECTION

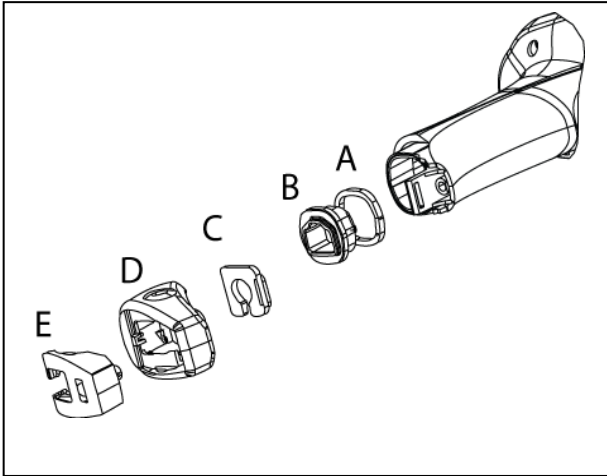

- A. Rubber gasket
- B. Plastic boot
- C. Cable spacer
- D. Cover
- E. Strain relief

Follow the given procedure for correct cable insertion:

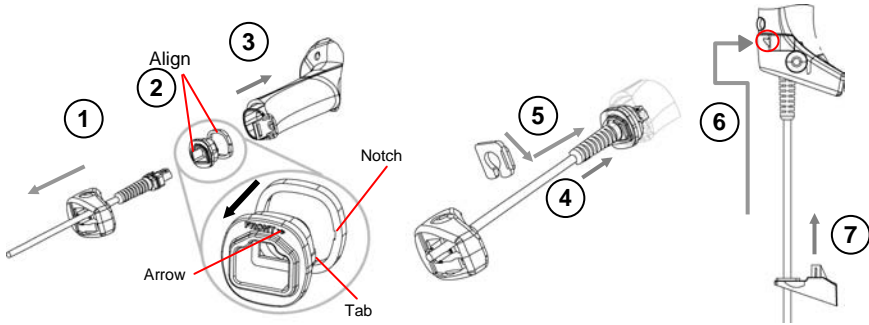

- ① Slip the cover over the cable.
- ② Push the plastic boot into the rubber gasket. Take care that the tab on the plastic boot is aligned with the notch in the rubber gasket.
- ③ Push the plastic boot and gasket into the handle. Ensure that the “Front” marking on the plastic boot is facing out, with the arrow pointing towards the front of the scanner.
- ④ Insert the cable into the socket of the plastic boot.
- ⑤ Insert the cable spacer into the cable wire and slide it towards the handle.
- ⑥ Push the cover along the cable towards the reader, and hook it over the yellow “tooth”.
- ⑦ Insert the strain relief into the cover and tighten the screw to fix the whole assembly to the reader handle.

2 USING POWERSCAN® PD8530

2.1 AIMING SYSTEM

The PowerScan® PD8530 reader uses an intelligent aiming system similar to those on cameras. By partially pulling the trigger, the aiming system indicates a field of view to be positioned over the code:

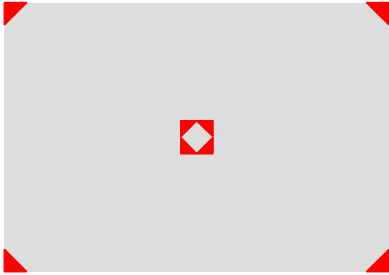

Figure 1 - Aiming System

When you pull the trigger completely a red beam illuminates the code. If the aiming system is centered and the entire symbology is within the aiming system, you will get a good read. The field of view changes size as you move the reader closer or farther away from the code.

Linear barcode



2D Matrix symbol

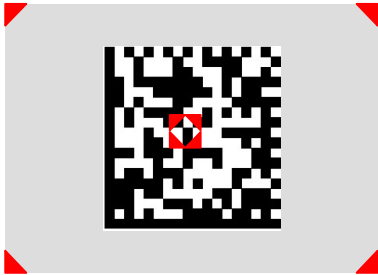

Figure 2 - Relative Size and Location of Aiming System Pattern

The field of view indicated by the aiming system will be smaller when the PowerScan® PD8530 is closer to the code and larger when it is farther from the code. Symbolologies with smaller bars or elements (mil size) should be read closer to the unit. Symbolologies with larger bars or elements (mil size) should be read farther from the unit. (See chapter 8 for further details).

2.2 NORMAL OPERATION

PowerScan® PD8530 normally functions by capturing and decoding codes.

Point the reader at the target and pull the trigger partially to enable the aiming system. Then, pull it completely to capture and decode the image. The reader will repeatedly flash until the symbol is decoded or timeout is reached. In between the flashes of the reader, the aiming system keeps on showing the field of view on the target (see Figure 2).

As you are reading code symbols, adjust the distance at which you are holding the reader.



NOTE

The PowerScan® PD8530 hand-held reader aiming system is designed for general reading and decoding of 1D and 2D symbols. Some variation in reading distance will occur due to narrow bar width and other factors.



NOTE

If reading codes positioned on reflective surfaces, it may be necessary to tilt the reader with respect to the barcode and/or set the Camera Control parameters (see page 53).

2.3 IMAGE CAPTURING

PowerScan® PD8530 can also function as a camera by capturing images of labels, signatures, and other items.

In order to capture an image, the user should read a Capture Image code (see page 76), then point at the image subject and pull the trigger. This way, the image will be captured and sent to the host PC. PowerScan® PD8530 then returns to normal operation. To capture another image you must read another Capture Image Code of the same or a different Preset Configuration.

You can use the aiming system to position the reader from the object (ensure the reader is about centered over the target). Adjust the distance at which you are holding the reader (see Figure 2).

If the RS-232 interface has been selected, the image will be transferred to the host PC via XMODEM_1K protocol.

**NOTE**

Image capturing is not available in Wedge and USB Keyboard Emulation interfaces and is not compatible with Autoscanning nor when the Software trigger type is selected.

Up to four different and independent Image Presets can be defined (see page 77).

2.3.1 Basic Configuration Parameters

The Image file formats supported are: TIFF, JPEG (default).

Two resolution options are available: Full Resolution (1280 x 1024 pixels) (default), and Half Resolution (640 x 512 pixels). The lower resolution setting yields smaller file sizes, so the transfer time decreases.

For JPEG images it is possible to define the Image Quality level to address tradeoff between image file size and quality.

2.3.2 Advanced Configuration Parameters

By default, for all Image Presets, the window has its origin coordinates equal to zero, its width equal to 1280 pixels and its height to 1024 pixels.

Brightness Adjustment is available in the range from –100% up to 100%, in steps of 1%. Positive values shift the luminance up so that the image will result brighter. Default value is 0%, meaning that no brightness adjustment is performed.

The same range of values (–100% up to 100%, in steps of 1%) is available for Contrast Adjustment. Positive values will increase the contrast, so that dark and bright objects inside the image will be better distinguishable. Default value is 0%, which means that no contrast adjustment is performed.

You can set the Image Color Depth by selecting 256 gray levels (default), 16 gray levels, or 2 gray levels. Higher color depths yield larger image files. This option is ignored if the JPEG format is selected,(256 gray levels only).

2.4 AUTOSCANNING

2.4.1 Normal Mode

PowerScan® PD8530 provides an **autoscan** command (see page 74), which when enabled, causes the reader to scan continuously and to monitor the central zone of its reading area. In this way, PowerScan® PD8530 is ready to capture any image (containing a potential code) positioned on a uniform background.

The aiming system can be enabled to indicate the reading area of the potential code to be captured. The illumination system can also be enabled when the ambient light conditions are not sufficient to autodetect the potential code to be captured; furthermore, the illumination system increases in intensity for an instant when capturing and decoding an image. A safety time may be defined to prevent PowerScan® PD8530 from reading the same code repeatedly.

If the decoding is completed successfully, the reader starts monitoring the reading area again. In case of decoding failure, PowerScan® PD8530 keeps on decoding until a potential code is present in the central zone of the reading area.

2.4.2 Pattern Mode

The Autoscan pattern mode is particularly advised when reading barcodes positioned on a non-uniform background. In these cases PowerScan® PD8530 may perceive some elements of the background as barcodes and start the decoding. To avoid this

undesired effect, the Autoscan Pattern Code is placed in the PowerScan® PD8530 reading area which prevents decoding. Using this code as the background, code reading takes place normally by presenting desired codes to be read over the Pattern Code. Between each code read, the Pattern Code must be presented to the reader.

The Pattern Code can be printed from the file of the manual (Appendix D) available on the CD-ROM.

In case of low ambient light conditions, PowerScan® PD8530 automatically activates the illumination system. If desired, the illumination system can be enabled so that it is always active.

2.5 CAMERA CONTROL

Exposure and Calibration

Three automatic control modes are available to get the best tuning of the image to be captured:

- Automatic based on entire image: camera control mode based on the analysis of the whole image. This mode works well in most standard applications. It is the default setting.
- Automatic based on central image: camera control mode based on the analysis of a restricted area positioned in the central zone of the image. This mode is suggested when reading small codes positioned in a dark and extensive background.
- Automatic for highly reflective surfaces: camera control mode allowing reading of codes on highly reflective surfaces. This mode is suggested, for example, when reading codes positioned on plastic or metal surfaces.

Refer to page 53 for configuration codes.

2.6 DEFINING DATA FORMATTING

The string of a decoded code to be sent to the host may be formatted as follows:

- defining simple **data formatting** (see page 43);
- defining **advanced data formatting** giving complete flexibility in changing the format of data (see par. 4.3).

When both simple and advanced data formatting are selected the info is processed in the following order:

1. the string of the decoded code is processed according to the advanced formatting rules;
2. the resulting string is processed according to the selection type rules of the simple data formatting;
3. character substitution is performed on the resulting string;
4. character deletion is performed on the resulting string;
5. code concatenation is performed;
6. code ID is attached to the resulting string;
7. global headers and terminators are attached to the resulting string;

The codes to be sent to the host may also be selected or ordered depending on the following two conditions:

- **one code per scan:** PowerScan® PD8530 sends the code being closest to the image center. If the "Central Code Transmission" command is enabled, only the code containing the image center will be transmitted (see page 73);
- **all codes per scan:** the codes to be sent to the host may be ordered either by length or by symbology starting from the code being closest to the image center (see page 73). When enabling both these criteria, codes belonging to the same symbology are sent to the host depending on their length.

2.6.1 Concatenation

It is possible to concatenate up to 4 different codes, set their length and enable the intercode delay between them (the intercode delay is set in the specific interface parameters, see page 28, 30 and 35). When enabling the delay one or more global headers and terminators are added to the decoded data. The concatenation procedure may occur in different ways depending on the number of codes to be decoded per image:

One Code Per Scan

- If the code resulting from the single decoding of an image belongs to one of the code families to be concatenated, it is saved to the PowerScan® PD8530 memory waiting for other codes to complete the concatenation.
- If the code belongs to the same family of a code previously saved, it overwrites the old one.
- If the code resulting from the decoding does not belong to one of the code families to be concatenated, it causes the concatenation failure and clears the temporary memory. If the "Concatenation Failure Transmission" command is set to "Tx codes causing failure" (see page 51), this code will be sent in the output message.

All Codes Per Scan

- All codes resulting from the decoding of an image and belonging to one of the families to be concatenated are saved to the PowerScan® PD8530 memory waiting for other codes to complete the concatenation.
- If one or more codes resulting from the decoding belong to the same family of codes previously saved, they overwrite the old ones.
- When the image contains no code to be concatenated, the concatenation fails and the reader temporary memory is cleared. If the "Concatenation Failure Transmission" command is set to "Tx codes causing failure" (see page 51), the codes causing the concatenation failure will be sent in the output message.

3 INITIAL SETUP

This procedure allows setting up the reader to operate with the default settings.

Whenever you need to change the default values refer to par. 4.2.

3.1 RS-232 INTERFACE SELECTION

The PowerScan® PD8530 reader requires the RS-232 interface cable and the AC/DC power adapter to be connected.

To install and configure your reader with the RS-232 interface, follow these instructions:

1. Make all system connections as shown in Figure 3:

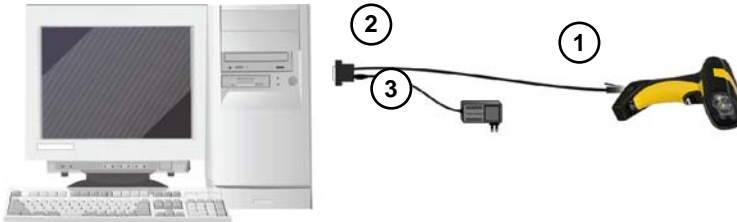

Figure 3 - RS-232 Connection

2. Read the restore default parameter code below:

Restore Default



3. Read the RS-232 interface selection code:

RS-232



4. Power up your PC.

RS-232 is the default interface set at the factory.

3.2 WEDGE INTERFACE SELECTION

The PowerScan® PD8530 reader requires the Wedge interface cable and the AC/DC power adapter to be connected.

To install and configure your reader with the Wedge interface, follow these instructions:

1. Make all the PowerScan® PD8530 reader connections as shown in Figure 4:

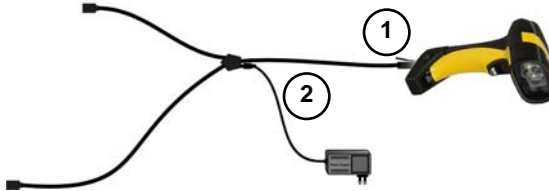

Figure 4 – Reader Wedge Connections

2. Read the restore default parameter code below:

Restore Default



3. Read the Wedge IBM AT interface selection code:

Wedge – IBM AT



4. Make all PC system connections as shown in Figure 5:



Figure 5 – PC Wedge Connection

5. Power up your PC.



CAUTION

When not using the PowerScan® PD8530 reader remember to disconnect the Wedge interface from the PC before disconnecting the power cord.



NOTE

While using the PowerScan® PD8530 it is always necessary to use cables adopting an external power supply.

3.3 USB INTERFACE SELECTION

The PowerScan® PD8530 reader requires the USB interface cable and the AC/DC power adapter to be connected.

The USB interface is compatible with:

Windows 98 (and later)

IBM POS for Windows

Mac OS 8.0 (and later)

4690 Operating System

To install and configure your reader with one of the USB interfaces, follow these instructions.

1. Make all the PowerScan® PD8530 reader connections as shown in Figure 6;



Figure 6 – Reader USB Connections

2. Read the restore default parameter code below:

Restore Default



3. Read the desired USB interface selection code:

USB-COM EMULATION



USB-KBD EMULATION



USB BULK



USB Generic HID



4. Connect the USB cable to PC as shown in Figure 7. The PC automatically recognizes the device and asks to install the device driver.



Figure 7 – PC USB connection

5. Install the USB driver on your PC (the first time only) to complete the connection.
- For USB Bulk the relevant files and drivers must be installed from the CD-ROM. See the “DLBulkUSB User Guide” file provided on the CD-ROM for more information.
 - For USB COM the relevant files and drivers must be installed from the USB Device Installation software which can be downloaded from the web site <http://www.scanning.datalogic.com>.
 - For USB Keyboard and for USB Generic HID the correct USB driver is included in the Host Operating System and will either be loaded automatically or will be suggested by the O.S. and should therefore be selected from the dialog box.



NOTE

The PowerScan® PD8530 reader is a USB self-powered device.



NOTE

If you need to change the USB device interface, after having reconfigured the reader, you have to disconnect and reconnect the cable to the PC.

3.4 IBM USB

To install and configure your reader with one of the USB interfaces, follow these instructions.

1. Make all the PowerScan® PD8530 reader connections as shown:

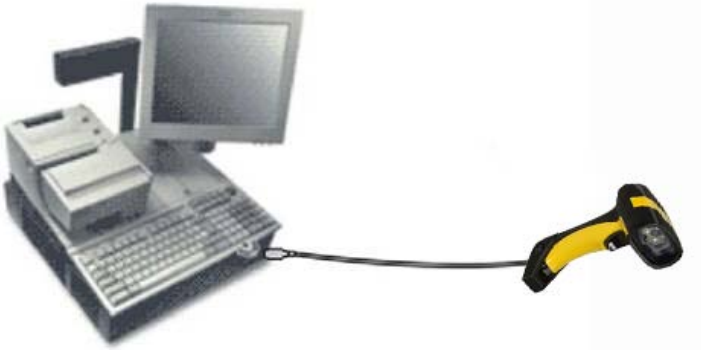

2. Read the IBM USB interface selection code below:

IBM USB



4 CONFIGURATION USING CODE SYMBOLS

This section describes the programming method of using configuration code symbols to program your reader. By using the PowerScan® PD8530 reader to read/decode these special configuration symbols, you can configure, and obtain information from its system software.

When you are reading configuration code symbols, carefully aim the PowerScan® PD8530 2D reader to avoid reading adjacent symbols.

The configuration code symbols in this chapter are divided into logical sections according to the type of configuration required, (RS-232 configuration, Code selection, etc.). If arguments are required with a command, you can read additional code labels (typically digits) from Appendix D.

To configure your reader:

1. Read the **Enter Configuration** code ONCE, available on top of each page.
2. Modify the desired parameters in one or more sections by reading the parameter code and selecting the value from the Hex/Numeric table (see Appendix D) or by following the given procedures.
3. Read the **Exit and Save Configuration** code ONCE, available on top of each page.

Example for step 3:

To set the maximum length of characters in a Code 39 barcode symbol that the reader will decode to 32:

- first read the Maximum Length symbol for Code 39 on page 57
- then read the symbol for the digit "3" and lastly the symbol for the digit "2" in Appendix D.

4.1 DEFAULT SETTINGS

Configuration Field	Default Setting
RS-232 Communication Baud Rate Parity, Data Bits, Stop Bits Handshake ACK/NACK Protocol FIFO Intercharacter Delay Intercode Delay RX Timeout Serial Trigger Lock Serial Trigger Lock Disable Character Serial Trigger Lock Enable Character	115200 No parity; 8 Data bits; 1 Stop bit None None Enabled 0 0 10 seconds Disabled NUL NUL
USB COM Emulation Handshake ACK/NACK Protocol FIFO Intercharacter Delay Intercode Delay RX Timeout	None None Enabled 0 0 10 seconds
USB Keyboard Emulation FIFO Intercharacter Delay Intercode Delay *Keyboard Nationality *Keyboard Speed	Enabled 0 0 USA Normal
WEDGE-Communication *Keyboard Nationality CapsLock CapsLock Auto-Recognition NumLock Intercharacter Delay Intercode Delay	USA OFF ON OFF 0 0
IBM USB Interface DEFAULT SETTINGS device usage	Handheld

• The default values of these parameters are set when reading the interface selection.

<p>Data Format-Symbology Independent Parameters</p> <p>Code Identifier Custom Code Identifier Code Length *Header *Terminator</p>	<p>Disabled Disabled Disabled No headers CR and LF terminators for RS-232, USB BULK, USB COM, USB Generic HID ENTER terminator for Wedge, USB Kbd</p>
<p>Data Format-Symbology Dependent Parameters</p> <p>Symbology Specific Format Header Symbology Terminator Symbology Symbology Character Substitution Symbology Character Deletion</p>	<p>Select All No headers No terminators No character to substitute No character to delete</p>
<p>Data Format-Concatenation</p> <p>Concatenation Define Concatenation Set First Concatenated Code Length Set Second Concatenated Code Length Set Third Concatenated Code Length Set Fourth Concatenated Code Length Concatenation with Intercode Delay Concatenation Timeout Concatenation Failure Transmission Transmission after Timeout Concatenation Result Code ID</p>	<p>Disabled 2 EAN/UPC codes concatenated 000 = any length 000 = any length 000 = any length 000 = any length Disabled 10 seconds Tx codes causing failure No code transmission No code Identifier</p>
<p>Advanced Formatting</p> <p>Format enable/disable</p>	<p>Disabled</p>
<p>Camera Control</p> <p>Exposure Mode</p>	<p>Automatic, based on entire image</p>
<p>Power Save</p> <p>Illumination Power Illumination System Power</p>	<p>Max power ON</p>
<p>Code Selection</p> <p>Issue Identical Codes</p>	<p>Enabled</p>
<ul style="list-style-type: none"> The default values of these parameters are set when reading the interface selection. 	

EAN/UPC Selection Add-On UPCE Expansion	Enabled Disabled Disabled
Code 39 Selection Code39 Full ASCII Code Length Check Minimum Length Maximum Length Start/Stop Character	Enabled - no check digit Disabled Disabled 001 255 Disabled
Code 32 Selection	Disabled
Interleaved 2 of 5 Selection Code Length Check Minimum Length Maximum Length	Disabled Disabled 014 255
Codabar Selection Code Length Check Minimum Length Maximum Length	Disabled Disabled 001 255
Code 128 Code128 Selection Code Length Check Minimum Length Maximum Length	Enabled Disabled 001 255
EAN 128 Selection Code Length Check Minimum Length Maximum Length	Disabled Disabled 001 255
Code 93 Selection Code Length Check Minimum Length Maximum Length	Disabled Disabled 001 255

<p>PDF417</p> <p>Selection</p> <p>Option</p> <p>Micro PDF417</p>	<p>Enabled</p> <p>Macro PDF417 Buffered Mode</p> <p>Disabled</p>
<p>GS1 DataBar™ Family</p> <p>GS1 DataBar Expanded</p> <p>GS1 DataBar Limited</p> <p>GS1 DataBar Omnidirectional</p> <p>GS1 DataBar Expanded Stacked</p> <p>GS1 DataBar Stacked</p>	<p>Disabled</p> <p>Disabled</p> <p>Disabled</p> <p>Disabled</p> <p>Disabled</p>
<p>Data Matrix</p> <p>Selection</p> <p>Rectangular Style</p> <p>Minimum Code Length</p> <p>Maximum Code Length</p>	<p>Enabled - normal & inverted</p> <p>Enabled</p> <p>0001</p> <p>3600</p>
<p>QR</p> <p>Selection</p>	<p>Enabled</p>
<p>Postal Codes</p> <p>Selection</p>	<p>Disabled</p>
<p>Australian Table</p> <p>Selection</p>	<p>N Table</p>
<p>Maxicode</p> <p>Maxicode Mode 0</p> <p>Maxicode Mode 1</p> <p>Maxicode Mode 2</p> <p>Maxicode Mode 3</p> <p>Maxicode Mode 4</p> <p>Maxicode Mode 5</p> <p>Maxicode Mode 6</p>	<p>Disabled</p> <p>Disabled</p> <p>Disabled</p> <p>Disabled</p> <p>Disabled</p> <p>Disabled</p> <p>Disabled</p>
<p>Aztec</p> <p>Selection</p>	<p>Disabled</p>
<p>Composite Codes</p> <p>Selection</p> <p>Discard Linear Part</p>	<p>Disabled</p> <p>Enabled</p>
<p>Reading Parameters</p> <p>Trigger Mode</p> <p>Trigger Type</p> <p>Flash ON</p>	<p>Trigger level</p> <p>Normal trigger</p> <p>2 sec</p>

CONFIGURATION USING CODE SYMBOLS

Flash OFF Beeper Tone Beeper Volume Beeper Duration Reads per Cycle Scan Timeout User Defined Beeper Tone User Defined Beeper Volume User Defined Beeper Duration Codes per Scan Central Code Transmission	2 sec Tone 1 High volume 50 ms One read per cycle 5 sec Tone 1 High Volume 100 ms One code per scan Disabled
Reading Parameters (continued) Order by Code Length Order by Code Symbology Autoscan Mode Autoscan Aiming System Autoscan Hardware Trigger Autoscan Illumination System Safety Time	Disabled Disabled Disabled Enabled Enabled Disabled 500 ms (if Autoscan mode or Software trigger type is selected and the Multiple Reads per Cycle option is enabled.)
Image Formatting <i>Image Preset 1, 2, 3, 4</i> Image Format Resolution Set JPEG Quality Factor Brightness Contrast Color Depth	JPEG format Full (1280 x 1024) 50 0% 0% 256 gray levels

4.2 CHANGING DEFAULT SETTINGS

Once the reader is set up, you can change the default parameters to meet your application needs. Refer to the preceding paragraphs for initial configuration in order to set the default values and select the interface for your application.

In this manual, the configuration parameters are divided into logical groups making it easy to find the desired function base on its reference group.

The **RS-232**, **USB**, **WEDGE** groups are for Standard Interface parameter configuration.

The following parameter groups are common to all interface applications:

- **DATA FORMAT** parameters regard the messages sent to the Host system.
- **CAMERA CONTROL** parameters regard the control mode managing the camera.
- **POWER SAVE** parameters manage overall current consumption in the device.
- **CODE SELECTION** parameters allow configuration of a personalized mix of codes, code families and their options.
- **READING PARAMETERS** control various operating modes and indicators status functioning.
- **CAPTURE IMAGE** parameters activate image capturing.
- **ADVANCED CAPTURE IMAGE** parameters define options of the image to capture.
- **ADVANCED DATA FORMAT** parameters allow advanced formatting of messages towards the Host.

Once the configuration is modified, it is possible to save it as a Custom Default Configuration and to restore it at any time using a specific command.

SAVE CUSTOM DEFAULT



RESTORE CUSTOM DEFAULT





RS-232 INTERFACE

BAUD RATE

1200 baud



2400 baud



4800 baud



9600 baud



14400 baud



19200 baud



38400 baud



57600 baud



115200 baud



Enter Reader Configuration



RS-232

Exit and Save Reader Configuration



PARITY

None



Odd



Even



DATA BITS

7 Bits



8 Bits



STOP BITS

1 Bit



2 Bits



ACK/NACK PROTOCOL

Disabled



Enabled



See par. 5.1.1 for details.

Enter Reader Configuration



RS-232

Exit and Save Reader Configuration



RX TIMEOUT

RX Timeout



Read a number in the range
00-99, where:
00 = disabled
01-99 = timeout from 1 to 99 secs

See par. 5.1.2 for details.

SERIAL TRIGGER LOCK

Disabled



Enabled



Serial Trigger Lock Characters



Read two characters for Serial Trigger Lock/Unlock.
The 2 characters must be read sequentially as Hex values from the Hex/Numeric table.
Valid values are in the range 00-FF

HANDSHAKE

None



XON/XOFF



RTS/CTS



RTS Always On



Enter Reader Configuration



RS-232

Exit and Save Reader Configuration



FIFO

Disabled



Enabled



INTERCHARACTER DELAY

Intercharacter Delay



00 = disabled

01-99 = delay from 1 to 99 msec

INTERCODE DELAY

Intercode Delay



00 = disabled

01-99 = delay from 1 to 99 sec

Enter Reader Configuration



USB

Exit and Save Reader Configuration



USB

USB COM Emulation

HANDSHAKE

None



XON/XOFF



RTS/CTS



ACK/NACK PROTOCOL

Disabled



Enabled



See par. 5.1.1 for details.

FIFO

Disabled



Enabled





USB



INTERCHARACTER DELAY

Intercharacter Delay



00 = disabled
01-99 = delay from 1 to 99 msec

INTERCODE DELAY

Intercode Delay



00 = disabled
01-99 = delay from 1 to 99 sec

RX TIMEOUT

RX Timeout



Read a number in the range
00-99, where:
00 = disabled
01-99 = timeout from 1 to 99 secs

See par. 5.1.2 for details.

Enter Reader Configuration



USB

Exit and Save Reader Configuration



USB Keyboard Emulation

FIFO

Disabled



Enabled



INTERCHARACTER DELAY

Intercharacter Delay



00 = disabled

01-99 = delay from 1 to 99 msec

INTERCODE DELAY

Intercode Delay



00 = disabled

01-99 = delay from 1 to 99 sec

Enter Reader Configuration



Exit and Save Reader Configuration



USB

KEYBOARD NATIONALITY

This parameter default value is restored through the Interface Selection code and not Restore Default.

Belgian



English



French



German



Italian



Japanese



Spanish



Swedish



USA



Enter Reader Configuration



Exit and Save Reader Configuration



USB

KEYBOARD SPEED

This parameter default value is restored through the Interface Selection code and not Restore Default.

Normal



Fast



NOTE

After setting the Keyboard Speed, it is necessary to disconnect and reconnect the USB cable to the PC.

See par. 5.2.1 for details.

USB IBM

Tabletop



HandHeld



Enter Reader Configuration



WEDGE

Exit and Save Reader Configuration



WEDGE INTERFACE

CAPS LOCK

Caps Lock Off



Caps Lock On



CAPS LOCK AUTO-RECOGNITION

Disabled



Enabled



Note: Caps lock manual configuration is ignored when Caps Lock Auto-Recognition is enabled

NUM LOCK

Num Lock Off



Num Lock On



INTERCHARACTER DELAY

Intercharacter Delay



00 = disabled

01-99 = delay from 1 to 99 msec

Enter Reader Configuration



Exit and Save Reader Configuration



WEDGE

INTERCODE DELAY

Intercode Delay



00 = disabled
01-99 = delay from 1 to 99 sec

KEYBOARD NATIONALITY

This parameter default value is restored through the Interface Selection code and not Restore Default.

Belgian



English



French



German



Italian



Japanese



Spanish



Swedish



**WEDGE**

USA



KEYBOARD SETTING

The values set by this procedure are not effected by the Restore Default code but will be lost if the Interface Selection code is read.

Set Alphanumeric Keys



The reader can be used with terminals or PCs with various keyboard types and nationalities through a simple keyboard setting procedure.

Keyboard setting consists of communicating to the reader how to send data corresponding to the keyboard used in the application. The keys must be set in a specific order.

Press and release a key to set it.

Some characters may require more than one key pressed simultaneously during normal use (refer to the manual of your PC or terminal for keyboard use). The exact sequence must be indicated to the reader in this case pressing and releasing the different keys.

Example:

If one has to press the "Shift" and "4" keys simultaneously on the keyboard to transmit the character "\$" to the video, to set the "\$", press and release "Shift" then press and release "4".

Each pressed and released key must generate an acoustic signal on the reader, otherwise repress the key. Never press more than one key at the same time, even if this corresponds to the normal use of your keyboard.

Press "Backspace" to correct a wrong key entry. In this case the reader emits a wrong beep.

Note: "CAPS LOCK" and "NUM LOCK" must be off before starting the keyboard setting procedure. "SHIFT" must be repressed for each character and cannot be substituted by "CAPS LOCK".

1. Read the "Set Alphanumeric Keys" code.
2. Press the keys shown in the following table according to their numerical order.

WEDGE

Some ASCII characters may be missing as this depends on the type of keyboard: these are generally particular characters relative to the various national symbologies. In this case:

- **The first 4 characters (Shift, Alt, Ctrl, and Backspace) can only be substituted with keys not used, or substituted with each other.**
- Characters can be substituted with other single symbols (e.g. "SPACE") even if not included in the barcode set used.
- Characters can be substituted with others corresponding to your keyboard.

The reader signals the end of the procedure with 3 beeps indicating the keys have been registered.

01 : Shift		
02 : Alt		
03 : Ctrl		
04 : Backspace		
05 : SPACE	28 : 7	51 : N
06 : !	29 : 8	52 : O
07 : "	30 : 9	53 : P
08 : #	31 : :	54 : Q
09 : \$	32 : ;	55 : R
10 : %	33 : <	56 : S
11 : &	34 : =	57 : T
12 : '	35 : >	58 : U
13 : (36 : ?	59 : V
14 :)	37 : @	60 : W
15 : *	38 : A	61 : X
16 : +	39 : B	62 : Y
17 : ,	40 : C	63 : Z
18 : -	41 : D	64 : [
19 : .	42 : E	65 : \
20 : /	43 : F	66 :]
21 : 0	44 : G	67 : ^
22 : 1	45 : H	68 : _ (underscore)
23 : 2	46 : I	69 : `
24 : 3	47 : J	70 : {
25 : 4	48 : K	71 :
26 : 5	49 : L	72 : }
27 : 6	50 : M	73 : ~
		74 : DEL

Acoustic Signals

Four types of acoustic signals are associated with the following steps:

1. Enter keyboard setup
2. Exit keyboard setup
3. SHIFT, ALT, CTRL, BACKSPACE keys
4. Keyboard keys (SHIFT, ALT, CTRL, BACKSPACE excluded)

These signals facilitate the selection of those characters requiring more than one key pressed simultaneously.

Example

The transmission of the "%" character implies two different steps:

1. Press the SHIFT key
2. Press the "5" key

The different tones produced by the reader indicate that both steps have been successful and that the character has been transmitted.

WEDGE

EXTENDED HEADER/TERMINATOR KEYS

For the WEDGE interface, the following extended keyboard values can also be configured.

These values are restored through the Interface Selection code and not Restore Default.

EXTENDED KEYBOARD TO HEX CONVERSION	
	IBM AT
HEX	KEY
83	ENTER
84	TAB
85	F1
86	F2
87	F3
88	F4
89	F5
8A	F6
8B	F7
8C	F8
8D	F9
8E	F10
8F	F11
90	F12
91	HOME
92	END
93	PG UP
94	PG DOWN
95	↑
96	↓
97	←
98	→
99	ESC
9A	CTRL (Right)
9B	Euro

WEDGE

SET CUSTOM EXTENDED HEADER/TERMINATOR KEYS

Set Extended Keys



The extended Header/Terminator keys for **Wedge Interface users** can be customized by defining them through a simple keyboard setting procedure.

For example, the Numeric Keypad keys can be set for use as Headers or Terminators by substituting the default extended keys during this procedure.

Press and release a key to set it.

Some characters may require more than one key pressed simultaneously during normal use (refer to the manual of your PC or terminal for keyboard use). The exact sequence must be indicated to the reader in this case pressing and releasing the different keys.

Example:

If one has to press the "Shift" and "4" keys simultaneously on the keyboard to transmit the character "\$" to the video, to set the "\$", press and release "Shift" then press and release "4".

Each pressed and released key must generate an acoustic signal on the reader, otherwise repress the key. Never press more than one key at the same time, even if this corresponds to the normal use of your keyboard.

Press "Backspace" to correct a wrong key entry. In this case the reader emits a wrong beep.

Note: "CAPS LOCK" and "NUM LOCK" must be off before starting the keyboard setting procedure. "SHIFT" must be repressed for each character and cannot be substituted by "CAPS LOCK".

1. Read the "Set Extended Keys" code.
2. Press the first 4 keys indicated in the following table.
3. Define all keys from 5 to 28 in the following table.

WEDGE

If the first 4 KEYS (Shift, Alt, Ctrl, and Backspace) are not available on your keyboard, you can only substitute them with keys not used, or substitute them with each other.

The reader signals the end of the procedure with 3 beeps indicating the keys have been registered.

CUSTOM EXTENDED KEYBOARD SETTING TABLE		
		Custom
Order	HEX	KEY
01	-	Shift
02	-	Alt
03	-	Ctrl
04	-	Backspace
05	83	
06	84	
07	85	
08	86	
09	87	
10	88	
11	89	
12	8A	
13	8B	
14	8C	
15	8D	
16	8E	
17	8F	
18	90	
19	91	
20	92	
21	93	
22	94	
23	95	
24	96	
25	97	
26	98	
27	99	
28	9A	

WEDGE

Acoustic Signals

Four types of acoustic signals are associated with the following steps:

1. Enter keyboard setup
2. Exit keyboard setup
3. SHIFT, ALT, CTRL, BACKSPACE keys
4. Keyboard keys (SHIFT, ALT, CTRL, BACKSPACE excluded)

These signals facilitate the selection of those characters requiring more than one key pressed simultaneously.

Example

The transmission of the "%" character implies two different steps:

1. Press the SHIFT key
2. Press the "5" key

The different tones produced by the reader indicate that both steps have been successful and that the character has been transmitted.



DATA FORMAT



DATA FORMAT

The Data Format parameters can be restored to their default values using the following methods:

- 1) the general “Restore Default” code restores all the configuration parameter groups including Data Format to their default values, with the exception of the Symbology Independent Header and Terminator selections;
- 2) the “Data Format Default” code restores all the Data Format configuration parameters to their default values, with the exception of the Symbology Independent Header and Terminator selections;
- 3) the Symbology Independent Header and Terminator parameters are set to their default values when reading the interface selection code;
- 4) the “Symbology Specific Format Default” code restores only the configuration parameters of the specific symbology indicated by the Code Identifier code in Appendix C.

DATA FORMAT DEFAULT

Data Format Default



Symbology Independent Parameters

CODE IDENTIFIER

Disabled



Custom Code ID



Enter Reader Configuration



Exit and Save Reader Configuration



DATA FORMAT

AIM Standard Code ID



Datalogic Code ID



CUSTOM CODE IDENTIFIER

Custom Code Identifier



1. Select a Datalogic Standard Code Identifier from the Code Identifier Table in Appendix C.
2. Set the number of characters in the range **0-3**, where **0** = Code ID disabled.
3. Read the corresponding characters as Hex values from the Hex/Numeric table. Valid values are in the range **00-7F**.

CODE LENGTH

Disabled



Enabled



SET HEADERS

Set Headers



1. Set the number of characters in the range **00-10**.
2. Read the corresponding characters as Hex values from the Hex/Numeric table. Valid values are in the range:
00-7F for RS-232, USB BULK, USB COM, USB Generic HID
00-9B for Wedge and USB Keyboard
3. Read the following code to enable the configuration you have set.

Enter Reader Configuration



Exit and Save Reader Configuration



DATA FORMAT

HEADERS

Disabled



Enabled



SET TERMINATORS

Set Terminators



1. Set the number of characters in the range **00-10**.
2. Read the corresponding characters as Hex values from the Hex/Numeric table. Valid values are in the range:
00-7F for RS-232, USB BULK, USB COM, USB Generic HID
00-9B for Wedge and USB Keyboard
3. Read the following code to enable the configuration you have set.

TERMINATORS

Disabled



Enabled





DATA FORMAT

Symbology Dependent Parameters

The “Symbology Specific Format Default” code on page 49 allows restoring the symbology dependent parameters related to a specific code family to the default values.

SYMBOLGY SPECIFIC FORMAT

Symbology Specific Format



1. Select a Datalogic Standard Code Identifier from the Code Identifier Table in Appendix C.
2. Formatting:
 - 0 = select all - Step 3
 - 1 = select right - followed by Step 3
 - 2 = select left - followed by Step 3
 - 3 = select middle - followed by a number in the range **000-999** for the starting character and then, by Step 3
 - 4 = discard right - followed by Step 3
 - 5 = discard left - followed by Step 3
 - 6 = discard middle - followed by a number in the range **000-999** for the starting character and then, by Step 3
3. Set the number of characters to select/discard in the range **000-999**.

SYMBOLGY HEADERS

Symbology Headers



1. Select a Datalogic Standard Code Identifier from the Code Identifier Table in Appendix C.
2. Set the number of characters in the range **0-5**.
3. Read the corresponding characters as Hex values from the Hex/Numeric table. Valid values are in the range:
 - 00-7F** for RS-232, USB BULK, USB COM, USB Generic HID
 - 00-9B** for Wedge and USB Keyboard
4. Read the following code to enable the configuration you have set.

**DATA FORMAT*****HEADERS***

Headers



1. Select a Datalogic Standard Code Identifier from the Code Identifier Table in Appendix C.
2. 0 = disabled
1 = enabled

SYMBOLGY TERMINATORS

Symbology Terminators



1. Select a Datalogic Standard Code Identifier from the Code Identifier Table in Appendix C.
2. Set the number of characters in the range **0-5**.
3. Read the corresponding characters as Hex values from the Hex/Numeric table. Valid values are in the range:
00-7F for RS-232, USB BULK, USB COM, USB Generic HID
00-9B for Wedge and USB Keyboard
4. Read the following code to enable the configuration you have set.

TERMINATORS

Terminators



1. Select a Datalogic Standard Code Identifier from the Code Identifier Table in Appendix C.
2. 0 = disabled
1 = enabled



DATA FORMAT



SYBOLOGY CHARACTER SUBSTITUTION

Symbology Character Substitution



1. Select a Datalogic Standard Code Identifier from the Code Identifier Table in Appendix C.
2. Read the corresponding character as Hex value from the Hex/Numeric table which identifies the character to be substituted. Valid value is in the range **00-7F**.
3. Read the corresponding character as Hex value from the Hex/Numeric table which identifies the new substituting character. Valid value is in the range **00-7F**.
4. Read the following code to enable the configuration you have set.

CHARACTER SUBSTITUTION

Character Substitution



1. Select a Datalogic Standard Code Identifier from the Code Identifier Table in Appendix C.
2. 0 = disabled
1 = enabled

SYBOLOGY CHARACTER DELETION

Symbology Character Deletion



1. Select a Datalogic Standard Code Identifier from the Code Identifier Table in Appendix C.
2. Read the corresponding character as Hex value from the Hex/Numeric table which identifies the character to be deleted. Valid value is in the range **00-7F**.
3. Read the following code to enable the configuration you have set.

**DATA FORMAT*****CHARACTER DELETION***

Character Deletion



1. Select a Datalogic Standard Code Identifier from the Code Identifier Table in Appendix C.
2. 0 = disabled
1 = enabled

SYMBOLGY SPECIFIC FORMAT DEFAULTSymbology Specific Format
Default

Select a Datalogic Standard Code Identifier from the Code Identifier Table in Appendix C.

Concatenation***DEFINE CONCATENATION***

Define Concatenation



1. Select the number of codes to concatenate in the range **2-4**.
2. Select the Datalogic Standard Code Identifier for each code to concatenate (repeat for same code types) from the table in Appendix C.
3. Read the following Code to enable the configuration you have set.

CONCATENATION ENABLE/DISABLE

Disabled



Enabled





DATA FORMAT



Concatenation Options

FIRST CONCATENATED CODE LENGTH

Set First Concatenated Code
Length



Read the number in the range
000-255.
000 = any code length

SECOND CONCATENATED CODE LENGTH

Set Second Concatenated Code
Length



Read the number in the range
000-255.
000 = any code length

THIRD CONCATENATED CODE LENGTH

Set Third Concatenated Code
Length



Read the number in the range
000-255.
000 = any code length

FOURTH CONCATENATED CODE LENGTH

Set Fourth Concatenated Code
Length



Read the number in the range
000-255.
000 = any code length

Enter Reader Configuration



Exit and Save Reader Configuration



DATA FORMAT

CONCATENATION WITH INTERCODE DELAY

Disabled



Enabled



This parameter is enabled with concatenation activated (see par. 2.6.1 for details).

CONCATENATION FAILURE TRANSMISSION

TX Codes Causing Failure



No Code TX



See par. 2.6.1 for details

CONCATENATION TIMEOUT

Concatenation Timeout



05-99 = timeout from 5 to 99 seconds.

TRANSMISSION AFTER TIMEOUT

No Code Transmission



First Code Transmission



Second Code Transmission



Third Code Transmission



Enter Reader Configuration



Exit and Save Reader Configuration



DATA FORMAT

CONCATENATION RESULT CODE ID

No Code Identifier



Use First Code Identifier



Use Second Code Identifier



Use Third Code Identifier



Use Fourth Code Identifier





CAMERA CONTROL

EXPOSURE MODE

Automatic
(Entire Image)



Automatic (Central Part of Image)



Automatic for Highly
Reflective Surfaces



See par. 2.5 for details.

Enter Reader Configuration



POWER SAVE

Exit and Save Reader Configuration



POWER SAVE

ILLUMINATION SYSTEM POWER

Illumination System OFF



Illumination System ON



Enter Reader Configuration



CODE SELECTION Linear Symbologies

Exit and Save Reader Configuration



CODE SELECTION

Disable All Symbologies



Disable All Linear Symbologies



Disable All 2D Symbologies



ISSUE IDENTICAL CODES

Disabled



Enabled



See par. 5.3.1 for details.

Enter Reader Configuration



**CODE SELECTION
Linear Symbologies**

Exit and Save Reader Configuration



Linear Symbologies

UPC/EAN/JAN FAMILY

EAN/UPC/JAN Disabled



EAN/UPC/JAN Enabled



Add-On Disabled



Add-On Enabled



UPCE Expansion Disabled



UPCE Expansion Enabled



CODE 39 FAMILY

Code 39 Std - Disabled



Code 39 Std - No Check Digit
Control



Code 39 Std - Check Digit Control
without Transmission



Code 39 Std - Check Digit Control
and Transmission



Enter Reader Configuration



CODE SELECTION Linear Symbologies

Exit and Save Reader Configuration



Code 39 Full ASCII - Disabled



Code 39 Full ASCII - Enabled



Code Length Check - Disabled



Code Length Check - Enabled



Minimum Code Length



Read the number in the range
001-255.

Maximum Code Length



Read the number in the range
001-255.

Start-Stop Character
Transmission - Disabled



Start-Stop Character
Transmission - Enabled



CODE 32 FAMILY

Disabled



Enabled



Enter Reader Configuration



CODE SELECTION Linear Symbologies

Exit and Save Reader Configuration



INTERLEAVED 2 OF 5 FAMILY

Disabled



Enabled - No Check Digit
Control



Enabled - Check Digit Control
and without Transmission



Enabled - Check Digit Control
and Transmission



Code Length Check - Disabled



Code Length Check - Enabled



Minimum Code Length



Read the number in the range
001-255.

Maximum Code Length



Read the number in the range
001-255.

Enter Reader Configuration



**CODE SELECTION
Linear Symbologies**

Exit and Save Reader Configuration



CODABAR FAMILY

Disabled



Enabled - No Check Digit
Control



Enabled - Check Digit Control
without Transmission



Enabled - Check Digit Control
and Transmission



Code Length Check - Disabled



Code Length Check - Enabled



Minimum Code Length



Read the number in the range
001-255.

Maximum Code Length



Read the number in the range
001-255.

Enter Reader Configuration



**CODE SELECTION
Linear Symbologies**

Exit and Save Reader Configuration



CODE 128 FAMILY

Code 128 - Disabled



Code 128 - Enabled



Code Length Check - Disabled



Code Length Check - Enabled



Code 128 - Min. Code Length



Read the number in the range
001-255.

Code 128 - Max. Code Length



Read the number in the range
001-255.

EAN 128 - Disabled



EAN 128 - Enabled



Enter Reader Configuration



CODE SELECTION Linear Symbologies

Exit and Save Reader Configuration



EAN 128 - Code Length Check
Disabled



EAN 128 - Code Length Check
Enabled



EAN 128 - Min. Code Length



Read the number in the range
001-255.

Maximum Code Length



Read the number in the range
001-255.

CODE 93 FAMILY

Disabled



Enabled



Code Length Check - Disabled



Code Length Check - Enabled



Minimum Code Length



Read the number in the range
001-255.

Enter Reader Configuration



CODE SELECTION Linear Symbologies

Exit and Save Reader Configuration



Maximum Code Length



Read the number in the range
001-255.

GS1 DATABAR™ FAMILY

Disable GS1 DataBar
Expanded



Enable GS1 DataBar Expanded



Disable GS1 DataBar Limited



Enable GS1 DataBar Limited



Disable GS1 DataBar
Omnidirectional



Enable GS1 DataBar
Omnidirectional



Disable GS1 DataBar
Expanded Stacked



Enable GS1 DataBar Expanded
Stacked



Disable GS1 DataBar Stacked



Enable GS1 DataBar Stacked



Enter Reader Configuration



CODE SELECTION
2D Symbologies

Exit and Save Reader Configuration



2D Symbologies

PDF417

Disabled



Enabled



Macro PDF417 Unbuffered
Mode



Macro PDF417 Buffered Mode



The following command carries out its specific function and does not require reading the Enter or Exit and Save Configuration codes.

Abort Macro PDF417 Buffered
Mode



It stops buffering the read codes at any time. All the buffered codes will not be saved.

MICRO PDF417

Disabled



Enabled



Enter Reader Configuration



CODE SELECTION 2D Symbologies

Exit and Save Reader Configuration



DATAMATRIX FAMILY

Disabled



Enabled



Minimum Code Length



Read the number in the range
0001-3600.

Maximum Code Length



Read the number in the range
0001-3600.

Rectangular Style – Disabled



Rectangular Style - Enabled



QR FAMILY

Disabled



Enabled



Enter Reader Configuration



CODE SELECTION
2D Symbologies

Exit and Save Reader Configuration



POSTAL CODES FAMILY

All Disabled



Australian Post - Enabled



Japan Post - Enabled



PLANET - Enabled



POSTNET - Enabled



POSTNET with B and B' -
Enabled



POSTNET and PLANET -
Enabled



POSTNET with B and B' and
PLANET - Enabled



KIX Code - Enabled



Royal Mail Code (RM4SCC) -
Enabled



Enter Reader Configuration



CODE SELECTION
2D Symbologies

Exit and Save Reader Configuration



AUSTRALIAN TABLE SELECTION

N Table



C Table



MAXICODE FAMILY

Maxicode Mode 0 - Disabled



Maxicode Mode 0 Enabled



Maxicode Mode 1 - Disabled



Maxicode Mode 1 - Enabled



Maxicode Mode 2 - Disabled



Maxicode Mode 2 - Enabled



Maxicode Mode 3 - Disabled



Maxicode Mode 3 - Enabled



Enter Reader Configuration



CODE SELECTION 2D Symbologies

Exit and Save Reader Configuration



Maxicode Mode 4 - Disabled



Maxicode Mode 4 - Enabled



Maxicode Mode 5 - Disabled



Maxicode Mode 5 - Enabled



Maxicode Mode 6 - Disabled



Maxicode Mode 6 - Enabled



AZTEC

Disabled



Enabled



Enter Reader Configuration



CODE SELECTION 2D Symbologies

Exit and Save Reader Configuration



COMPOSITE CODES



NOTE

Before enabling this symbology, it is necessary to enable the linear barcode family (among GS1 DATABAR, EAN128 or UPC/EAN) contained in the composite code to be read.

Disabled



Enabled



Keep Linear Part



Discard Linear Part





READING PARAMETERS

TRIGGER MODE

Trigger Level



Trigger Pulse



TRIGGER TYPE

Normal Trigger



Software Trigger



FLASH MODE

Flash ON Duration



Read a number in the range **01-99**, which corresponds to a max 9.9 seconds duration.

Flash OFF Duration



Read a number in the range **01-99**, which corresponds to a max 9.9 seconds duration.

Enter Reader Configuration



READING PARAMETERS

Exit and Save Reader Configuration



BEEPER TONE

Tone 1



Tone 2



Tone 3



Tone 4



BEEPER VOLUME

Beeper OFF



Low Volume



Medium Volume



High Volume



BEEPER DURATION

Beeper Duration



Read a number in the range
01-99, which corresponds to a
max 99 ms duration.

Enter Reader Configuration



READING PARAMETERS

Exit and Save Reader Configuration



READS PER CYCLE

One Read per Cycle



Multiple Reads per Cycle



SCAN TIMEOUT

Define Timeout



Read a number in the range **01-99**, which corresponds to a max 99 seconds duration. The timeout is activated when the decoding fails.

User Defined Beeper

USER DEFINED BEEPER TONE

Tone 1



Tone 2



Tone 3



Tone 4



Enter Reader Configuration



Exit and Save Reader Configuration



READING PARAMETERS

USER DEFINED BEEPER VOLUME

Beeper OFF



Low Volume



Medium Volume



High Volume



USER DEFINED BEEPER DURATION

Set Duration



Read a number in the range
01-99, which corresponds to a
max 990 ms duration.

TEST USER DEFINED BEEPER

The following command carries out its specific function and does not require reading the Enter or Exit and Save Configuration codes.

Test User Defined Beeper



See par. 8.1.2 for details.



Code Ordering and Selection

CODES PER SCAN

One Code per Scan



All Codes per Scan



CENTRAL CODE TRANSMISSION

The following command is available when working in "one code per scan".

Disabled



Enabled



See par. 2.6 for details.

ORDER BY CODE LENGTH

The following command is available when working in "all codes per scan".

Disabled



Enabled - Increasing Order



Enabled - Decreasing Order



**READING
PARAMETERS*****ORDER BY CODE SYMBOLOGY***

The following command is available when working in "all codes per scan".

Set Order



1. Select the number of codes in the range **0-9**.
2. Select the Datalogic Standard Code Identifier for each above defined code from the table in Appendix C.

See par. 2.6 for details.

Autoscan***AUTOSCAN MODE***

Disabled



Enabled in Normal Mode



Enabled in Pattern Mode



See par. 2.4 for details.

AUTOSCAN AIMING SYSTEM

Disabled



Enabled



Enter Reader Configuration



READING PARAMETERS

Exit and Save Reader Configuration



AUTOSCAN HARDWARE TRIGGER

Disabled



Enabled



AUTOSCAN ILLUMINATION SYSTEM

Disabled



Enabled



NOTE

The following commands can be activated only when One Code per Scan is enabled.

SAFETY TIME

Disabled



Enabled



Valid only with software trigger or autoscan enabled.

See par. 5.4.1 for details.

SAFETY TIME DURATION

Set Duration



Read a number in the range **01-99**, where 01 corresponds to 100 ms and 99 to 9.9 seconds.



CAPTURE IMAGE

In order to capture an image, you should read one of these codes (for further details see par. 2.3), then point at the image subject and pull the trigger. The image will be captured and sent to the host PC according to the Preset Configuration.

Capture Image using Preset 1



Capture Image using Preset 2



Capture Image using Preset 3



Capture Image using Preset 4





ADVANCED IMAGE CAPTURE

Image Preset 1

Basic Configuration

IMAGE FORMAT – PRESET 1

JPEG Format



TIFF Format



RESOLUTION – PRESET 1

Full Resolution (1280 x 1024)



Half Resolution (640 x 512)





ADVANCED IMAGE CAPTURE



JPEG QUALITY FACTOR – PRESET 1

JPEG Quality Factor



Set the JPEG compression level in the range **000-100**.

Advanced Configuration

BRIGHTNESS – PRESET 1

Increase



Read a number in the range **0-100**

Decrease



Read a number in the range **0-100**

CONTRAST – PRESET 1

Increase



Read a number in the range **0-100**

Enter Reader Configuration



ADVANCED IMAGE CAPTURE

Exit and Save Reader Configuration



Decrease



Read a number in the range
0-100

COLOR DEPTH – PRESET 1

2 Grey Levels*



16 Grey Levels*



256 Grey Levels



* only for TIFF Images.

Enter Reader Configuration



**ADVANCED
IMAGE CAPTURE**

Exit and Save Reader Configuration



Image Preset 2

Basic Configuration

IMAGE FORMAT – PRESET 2

JPEG Format



TIFF Format



RESOLUTION – PRESET 2

Full Resolution (1280 x 1024)



Half Resolution (640 x 512)



JPEG QUALITY FACTOR – PRESET 2

JPEG Quality Factor



Set the JPEG compression level
in the range **000-100**.



ADVANCED IMAGE CAPTURE



Advanced Configuration

BRIGHTNESS – PRESET 2

Increase



Read a number in the range
0-100

Decrease



Read a number in the range
0-100

CONTRAST – PRESET 2

Increase



Read a number in the range
0-100

Decrease



Read a number in the range
0-100

Enter Reader Configuration



ADVANCED IMAGE CAPTURE

Exit and Save Reader Configuration



COLOR DEPTH – PRESET 2

2 Grey Levels*



16 Grey Levels*



256 Grey Levels



* only for TIFF Images.



Image Preset 3

Basic Configuration

IMAGE FORMAT – PRESET 3

JPEG Format



TIFF Format



RESOLUTION – PRESET 3

Full Resolution (1280 x 1024)



Half Resolution (640 x 512)



JPEG QUALITY FACTOR – PRESET 3

JPEG Quality Factor



Set the JPEG compression level
in the range **000-100**.



ADVANCED IMAGE CAPTURE



Advanced Configuration

BRIGHTNESS – PRESET 3

Increase



Read a number in the range
0-100

Decrease



Read a number in the range
0-100

CONTRAST – PRESET 3

Increase



Read a number in the range
0-100

Decrease



Read a number in the range
0-100

Enter Reader Configuration



ADVANCED IMAGE CAPTURE

Exit and Save Reader Configuration



COLOR DEPTH – PRESET 3

2 Grey Levels*



16 Grey Levels*



256 Grey Levels



* only for TIFF Images.



Image Preset 4

Basic Configuration

IMAGE FORMAT – PRESET 4

JPEG Format



TIFF Format



RESOLUTION – PRESET 4

Full Resolution (1280 x 1024)



Half Resolution (640 x 512)



JPEG QUALITY FACTOR – PRESET 4

JPEG Quality Factor



Set the JPEG compression level
in the range **000-100**.



**ADVANCED
IMAGE CAPTURE**

Advanced Configuration

BRIGHTNESS – PRESET 4

Increase



Read a number in the range
0-100

Decrease



Read a number in the range
0-100

CONTRAST – PRESET 4

Increase



Read a number in the range
0-100

Decrease



Read a number in the range
0-100

Enter Reader Configuration



ADVANCED IMAGE CAPTURE

Exit and Save Reader Configuration



COLOR DEPTH – PRESET 4

2 Grey Levels*



16 Grey Levels*



256 Grey Levels



* only for TIFF Images.

4.3 ADVANCED DATA FORMAT

Advanced data format has been designed to offer you complete flexibility in changing the format of barcode data **before** transmitting it to the host system.

Up to 5 advanced code management formats can be defined by completing the four given procedures following the desired order:

- Format Definition
- Mismatch Result
- Enable/Disable Format
- Match Conditions

The formats defined will be restored to default values when reading the general "Restore Default" code given in par. 5.5.

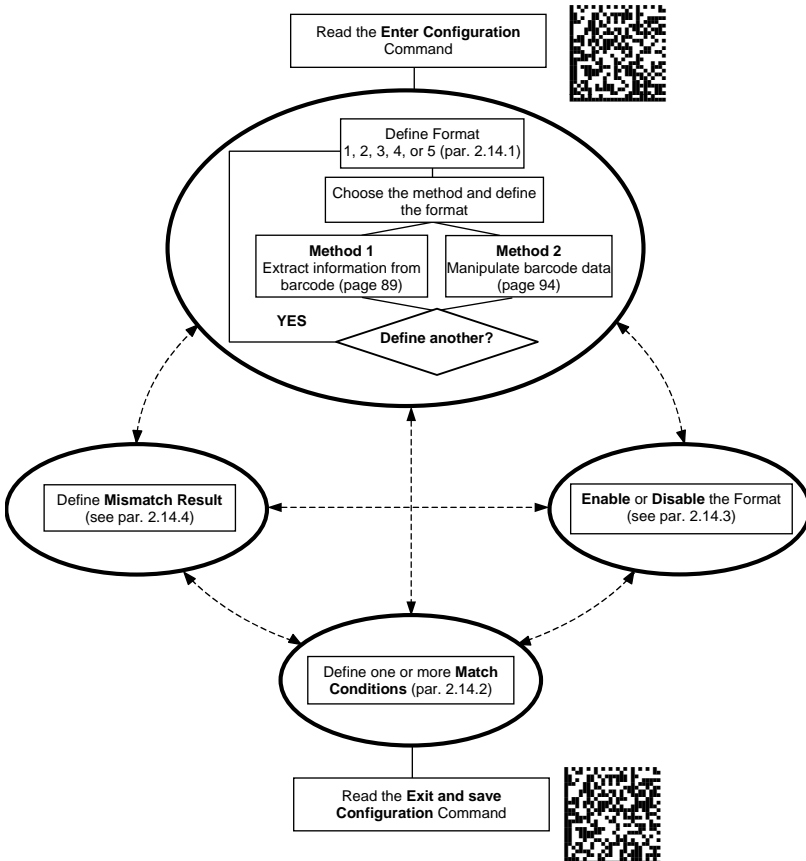

4.3.1 Format Definition

STEP 1	FORMAT DEFINITION
---------------	--------------------------

Define Format 1



Define Format 2



Define Format 3



Define Format 4



Define Format 5



STEP 2	FORMAT DEFINITION
---------------	--------------------------

Method 1 - Extracting Information from Barcode

Method 1 allows extracting one or more fields by position or by characters from the decoded barcode. These fields are sent to the host computer as data of the output message, while the characters not included in the formatting procedure will be deleted and not inserted in the output message.

These two kinds of extraction (by position / by character) can be used together within the same format definition; furthermore, it is possible to complete the new format by adding a new string of characters. Since there is no fixed rule, the procedures can be freely put in order and repeated according to your requirement.

The only limit is determined by the size of the internal reserved memory used to define the format.

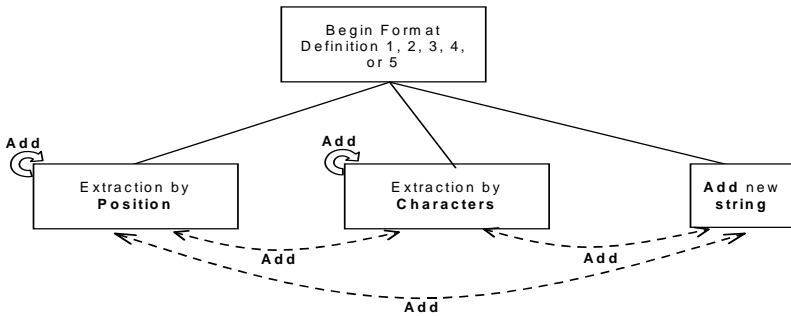

Example Method 1 Extracting Information from Barcode

Decoded code: <DATALOGICproduct>

Formatting procedure: Add new string + Extract field by position + Add new string + Extract field by character + Add new string

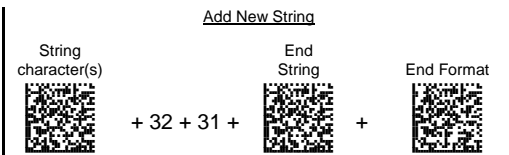
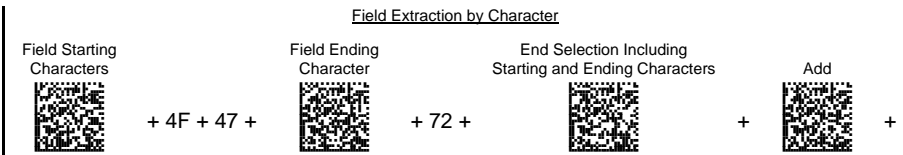
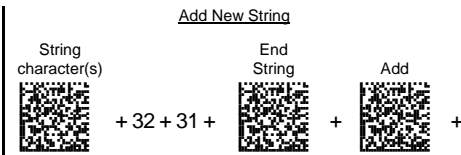
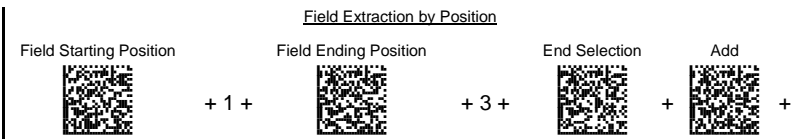
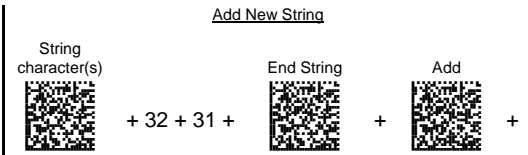

Output message: <21DAT21OGICpr21>

FIELD EXTRACTION BY CHARACTER

a) Define Field Starting Character(s)

Field Starting Character(s)



Read the Hex value from the Hex/Numeric table identifying the starting character(s) of the field to be extracted. Valid values are in the range **00-7F**.

b) Define Field Ending Character(s)

Field Ending Character(s)



Read the Hex value from the Hex/Numeric table identifying the ending character(s) of the field to be extracted. Valid values are in the range **00-7F**.

c) Field Delimiter Selection

Include Start/End Characters



Discard Start/End Characters



OR

d) EITHER Add Field or String

Add



- To add other fields selected by characters read the code and repeat this procedure from step **a** for each field to be selected;
- To add a new string of characters read the code and follow the procedure described on page 95;
- To add the procedure selecting new fields by position read the code and follow the description given on page 94.

OR

End Format Definition

End Format Definition



Read the code to end the format definition.

FIELD EXTRACTION BY POSITION

a)

Field Starting Position



Define Field Starting Position

Read a number corresponding to the field starting position.

b)

Field Ending Position



Read a number corresponding to the field ending position.

Define Field Ending Position

Last Position



OR

Read this code to set the field ending position to the last position of the code:

c)

End Selection



End Field Selection

Read the code to end the field selection.

d)

EITHER

Add



Add Field or String

- To add other fields selected by position read the code and repeat this procedure from step a for each field to be selected;
- To add a new string of characters read the code and follow the procedure described on page 95;
- To add the procedure selecting new fields by characters read the code and follow the description given on page 93.

OR

End Format Definition

End Format Definition



Read the code to end the format definition.

ADD NEW STRING

a)

Define New String

String Character(s)



Read the Hex value from the Hex/Numeric table identifying the character(s). Valid values are in the range **00-7F**.

b)

End String

End String



Read the code to end the string defined in step **a**.

c)

EITHER

Add Procedure

Add



- To add the procedure extracting fields by characters follow the steps given on page 93;
- To add the procedure extracting fields by position follow the steps given on page 94;

OR

End Format Definition

End Format Definition



Read the code to end the format definition.

Method 2 - Manipulating the Barcode Data

Method 2 allows modifying the barcode data by means of one of the following procedures:

- String insertion;
- String deletion;
- String substitution;
- Field deletion.

Once the data has been modified, it is sent to the host computer as data of the output message.

Unlike Method 1 this method does not allow associating different procedures together. This means that each format definition corresponds to a single procedure. Despite this, it is possible to add a new string of characters to the beginning or ending part of the formatted barcode.

The only limit is determined by the size of the internal reserved memory used to define the format.

STRING INSERTION

To complete this procedure proceed as follows:

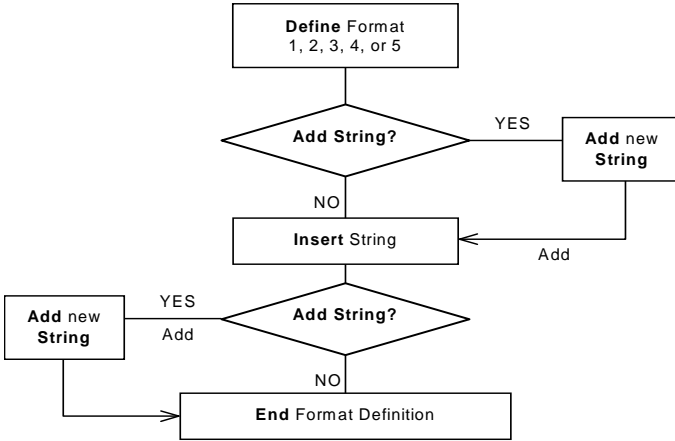

Example

Decoded code: <DATALOGICproduct>

Formatting procedure: Add new string + Insert String

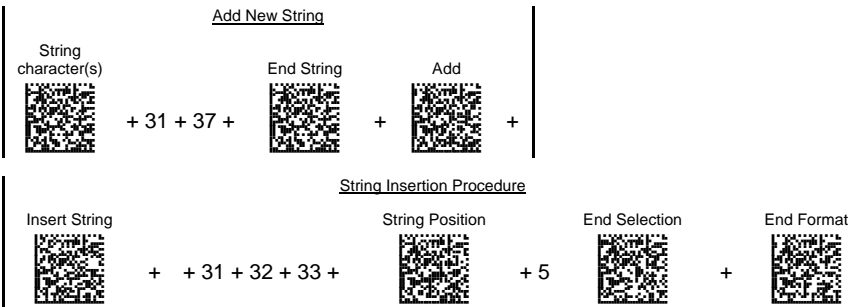

Output message: <17DATA123LOGICproduct>

String Insertion Procedure

a)

Insert String



Insert String

Read the Hex value from the Hex/Numeric table identifying the characters to be inserted. Valid values are in the range **00-7F**.

b)

String Position



Define String Position

Read a number corresponding to the string position within the barcode.

c)

End Selection



End Selection

Read the code to end the field selection.

d)

EITHER

Add



Add String

To add a new string of characters read the code and follow the procedure described on page 106;

OR

End Format Definition

End Format Definition



Read the code to end the format definition.

STRING DELETION

To complete this procedure proceed as follows:

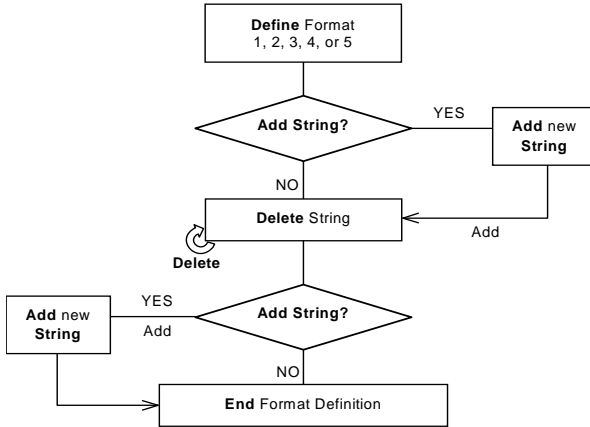

Example

Decoded code: <DATALOGICproduct>

Formatting procedure: Delete First String + Delete Second String + Add New String.

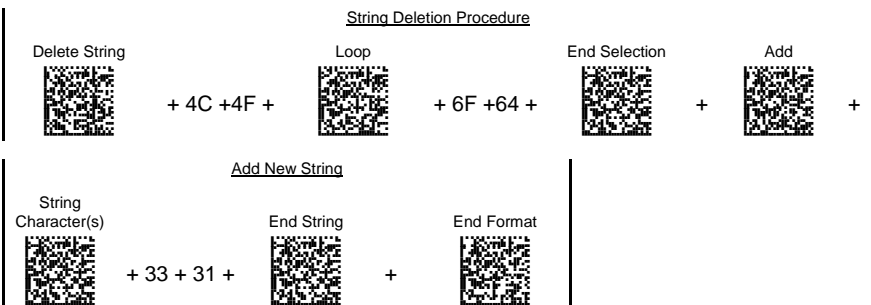

Output message: <DATAGICpruct31>

String Deletion Procedure

a)

Delete



Delete String

Read the Hex value from the Hex/Numeric table identifying the string character(s) to be deleted. Valid values are in the range **00-7F**.

b) (optional)

Loop



Select Other Strings to be Deleted

Read the code above and repeat the procedure from step a.

c)

End Selection



End Selection

Read the code to end the selection.

d)

EITHER

Add



Add String

To add a new string of characters read the code and follow the procedure described on page 106;

OR

End Format Definition

End Format Definition



Read the code to end the format definition.

STRING SUBSTITUTION

To complete this procedure proceed as follows:

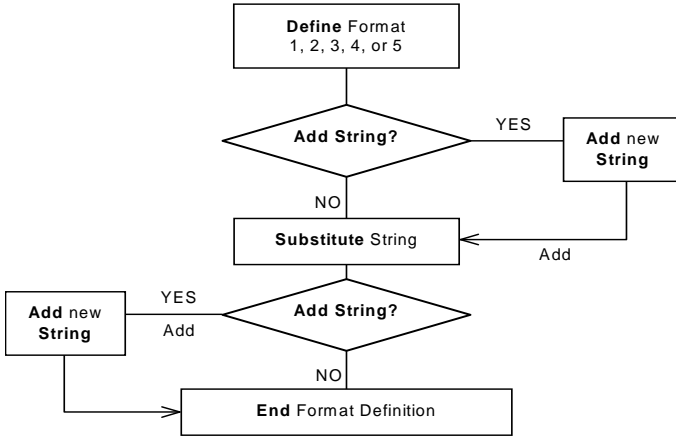

Example

Decoded code: <DATALOGICproduct>

Formatting procedure: Add new string + String substitution + Add new string.

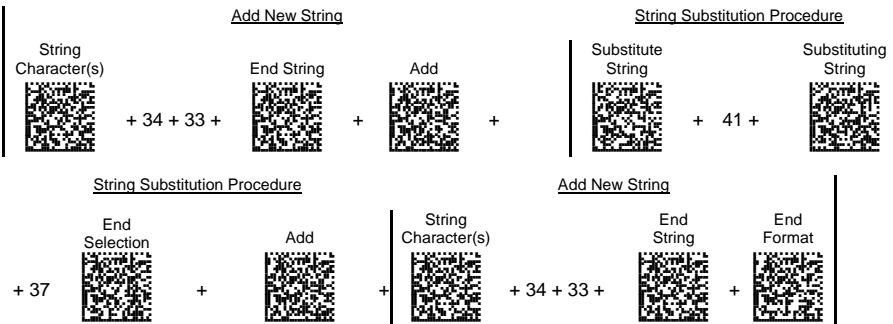

Output message: <43D7T7LOGICproduct43>

String Substitution Procedure

a)

Substitute String



Define String to be Substituted

Read the Hex value from the Hex/Numeric table identifying the characters of the string to be substituted. Valid values are in the range **00-7F**.

b)

Substituting String



Define Substituting String

Read the Hex value from the Hex/Numeric table identifying the characters of the substituting string. Valid values are in the range **00-7F**.

c)

End Selection



End Selection

Read the code to end the selection.

d)

EITHER

Add



Add String

To add a new string of characters read the code and follow the procedure described on page 106;

OR

End Format Definition



End Format Definition

Read the code to end the format definition.

FIELD DELETION

To complete this procedure proceed as follows:

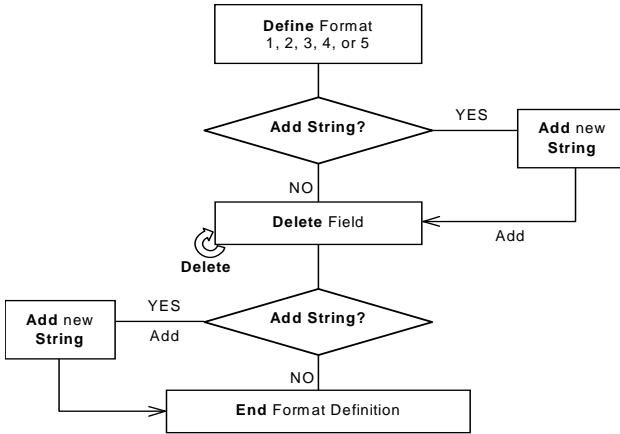

Example

Decoded code: <DATALOGICproduct>

Formatting procedure: Delete First Field + Delete Second Field + Add New String.

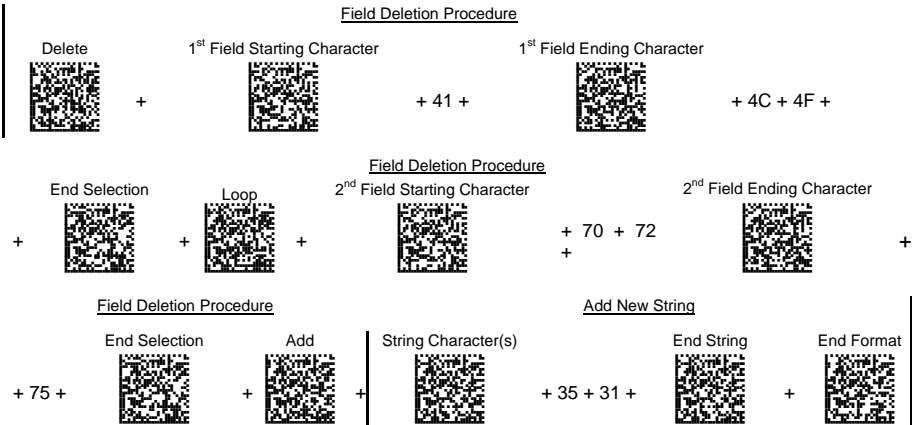

Output message: <DGICct51>

Field Deletion Procedure

a)

Delete



Delete Field

Read the code to enable the command deleting the field.

b)

Field Starting Character



Define Field Starting Character

Read the Hex value from the Hex/Numeric table identifying the starting characters. Valid values are in the range **00-7F**.

c)

Field Ending Character



Define Field Ending Character

Read the Hex value from the Hex/Numeric table identifying the ending character/s. Valid values are in the range **00-7F**.

d)

End Selection



End Field Selection

Read the code to end the field selection.

e)

(optional)

Loop



Select Other Fields to be Deleted

Read the following code and repeat the procedure from step **b** for each field to be deleted.

f) EITHER

Add String

Add



To add a new string of characters read the code and follow the procedure described on page 106;

OR

End Format Definition

End Format Definition



Read the code to end the format definition.

ADD NEW STRING

a)

String Character



Define New String

Read the Hex value from the Hex/Numeric table identifying the starting characters. Valid values are in the range **00-7F**.

b)

End String Plus Procedure



End String and Define Procedure

Read the code to end the string selection and continue defining a new procedure belonging to Method 1.

OR

End String & Format



End String and Format

Read the code to end the string and the format definition.

4.3.2 Match Conditions

By setting one or more of the following conditions it is possible to select the codes to be formatted. Follow the given steps to define the desired condition.

MATCH WITH PREDEFINED SUBSTRING

Match with Substring



Define Matching Substring

Read the above code and:

1. read a number in the range **1-5** corresponding to the desired format number;
2. set the number of characters defining the matching string in the range **00-10**;
3. read the corresponding character as Hex value from the Hex/Numeric table identifying the substring character/s. Valid values are in the range **00-7F**.

(optional)

Define Substring Position

Matching Substring Position



Read the above code and:

1. read a number in the range **1-5** corresponding to the desired format number;
2. read the number corresponding to the substring position in the range **0-255**;

AND/OR

MATCH CODE LENGTH

Define Code Length

Match Code Length



Read the above code and:

1. read a number in the range **1-5** corresponding to the desired format number;
2. read the number in the range **0-255**;

AND/OR

MATCH SYMBOLOGY

Define Code Symbology

Match Symbology



Read the above code and:

1. read a number in the range **1-5** corresponding to the desired format number;
2. set the number of the matching code symbologies in the range **0-4**;
3. select the Datalogic Standard Code Identifier from the Code Identifier Table in Appendix C.

4.3.3 Format Enable/Disable

Format 1



0 = disabled
1 = enabled

Format 2



0 = disabled
1 = enabled

Format 3



0 = disabled
1 = enabled

Format 4



0 = disabled
1 = enabled

Format 5



0 = disabled
1 = enabled

Disable All Formats



4.3.4 Mismatch Result

The result of each format may be set in case the match conditions previously selected are not satisfied.

Once the desired formats have been enabled and a code has been read, the results corresponding to each format will be concatenated together and transmitted in the output message. For this reason, it is strongly advised to set the mismatch result for each format.

Example

Decoded Code: <DATALOGICproduct>

Format definition:

Format	Enable/Disable	Match Condition	Function	Mismatch Result
Format 1	Enabled	Code having a length of 16 characters	Select field from position1 to position3	No string
Format 2	Disabled	/	/	/
Format 3	Enabled	Code having a length of 25 characters	Substitute string "ab" with string "12"	Unformatted read code
Format 4	Enabled	Code having the substring "AT" in position 2	Insert string "789" in position 7	Unformatted read code
Format 5	Enabled	Code belonging to the PDF417 symbology	Delete string "DA" and "pr"	Unformatted read code

Output message: <DATDATALOGICproductDATALO789GICproductDATALOGICproduct>

Format 1
Format 3
Format 4
Format 5

Define Mismatch Result

Mismatch Result



Read the above code and:

1. read a number in the range **1-5** corresponding to the desired format number;
2. 0 = empty string as output
1 = unformatted read code as output.

5 REFERENCES

5.1 RS-232 – USB COM

5.1.1 ACK/NACK Protocol

The transmission protocol takes place between reader and Host. Once the reader has read a code, it emits a good read beep and passes its data to the Host.

When ACK/NACK is disabled, there is no control from reader to Host transmission.

When ACK/NACK is enabled, the Host sends an ACK character (06 HEX) in the case of good reception or the NACK character (15 HEX) requesting re-transmission, in the case of bad reception.

If the reader does receive an ACK, no signal will be emitted; whereas, if it does not receive an ACK or NACK, it will emit a wrong reception tone after a few seconds.



NOTE

PowerScan® PD8530 reader cannot read barcodes while waiting for the Host response.

5.1.2 RX Timeout

This parameter can be used to automatically end data reception from the Host after the specific period of time.

If no character is received from Host, after the timeout expires, any incomplete string (any string not terminated by <CR>) is flushed from the device buffer.

5.2 USB KEYBOARD

5.2.1 Keyboard Speed

This parameter manages the transmission speed of characters to the Host. A fast Keyboard Speed allows rapid transmission of a great amount of characters (for example 2D codes), but it might not be compatible with slower systems.

5.3 CODE SELECTION

5.3.1 Issue Identical Codes

This parameter manages the code transmission when more than one code containing the same information is detected in a single scan. All identical codes are transmitted to the Host when the parameter is enabled; if disabled, only one of the identical codes is sent.

5.4 READING PARAMETERS





5.4.1 Safety Time

Safety time prevents the device from immediately decoding the same code more than once. A timeout can be set up to 9.9 seconds before the decoder will accept the same code. Reading is immediate if the code changes.

The safety time parameter is not applicable when all codes per scan is enabled or when setting one read per cycle in normal (hardware) trigger operating mode.

5.5 CONFIGURATION EDITING COMMANDS

The following commands carry out their specific function and do not require reading the Enter or Exit and Save Configuration codes.

Command	Description
	Restore PowerScan® PD8530 reader default configuration.
	Transmit the PowerScan® PD8530 reader Software release.
	Transmit the PowerScan® PD8530 current configuration in ASCII format to Host.
	Transmit the PowerScan® PD8530 current data format configuration in ASCII format to Host.

6 TEST CODE SYMBOLS

Use these 1D and 2D test symbols to check that the reader is imaging and decoding properly, according to your configuration.



QR



PDF417

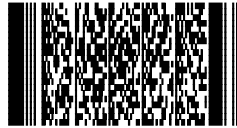

DataMatrix (Normal)



DataMatrix (Inverse)

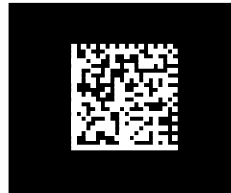

7 MAINTENANCE

You do not need to perform regular preventative maintenance on the PowerScan® PD8530 reader.

Do not try to open the case, because you might damage the interior electronic components and such action voids the warranty.

You can keep your reader in good operating condition by:

- periodically cleaning the reading window using water or a mild detergent solution and a soft cloth or tissue.
- watching for any damage to the housing.



CAUTION

Do not use abrasive cleaning agents on the reader's window to avoid scratches. Do not use solvents on the housing or window to avoid damage. Do not submerge the reader in water. It is not waterproof.

8 TECHNICAL FEATURES

PowerScan® PD8530 Family Common Features

Electrical Features	
Operating Voltage	5 to 30 V
Power Consumption @ 5V (Typical)	600 mA
@30V (Typical)	100 mA
Communications Features	
Standard Interfaces	RS-232, Keyboard emulation AT IBM, USB COM emulation, USB Keyboard emulation
Proprietary Interfaces	USB Bulk, USB Generic HID
Environmental Features	
Operating Temperature	-10° to +55° C (+14° to +131° F)
Storage Temperature	-20° to +70° C (-4° to +158° F)
Humidity	0 to 95% NC
Drop Resistance	2 m / 6.6 ft (over 50 drops to concrete)
IP Sealing	IP65
Mechanical Features	
Dimensions	20.8 x 6.6 x 11 cm / 8.1 x 2.6 x 4.3 in
Weight	295 g / 10.4 oz (without cable)
Decoding Capability	
1D	Interleaved 2 of 5, Code 39, Code 32, Code 128, EAN 128, Code93, UPC/EAN/JAN, Codabar, GS1 DataBar™
2D	Aztec, PDF417, Micro PDF417, Macro PDF417, Maxicode, DataMatrix (ECC200), QR, Composite Codes
Postal Codes	PLANET, Japan Post, Australia Post, KIX Code, Royal Mail Code (RM4SCC)
Imaging Options	
Image	1280x1024 pixels (Full Resolution) 640 x 512 pixel format (Half Resolution);
Graphic Format	JPEG, 256 gray levels TIFF, 2, 16, 256 gray levels
Optical Features	
Sensor	1280 x 1024 pixel element, 2D CMOS Array
Illuminator	LED array
Wavelength	In the range 630 ~ 670 nm
LED Safety Class	Class 1 to EN 60825-1
Aiming System	Visible Laser Diode
Wavelength	650 nm
Laser Safety Class	Class 2 - EN 60825-1; Class II CDRH
Ambient light	0 - 100000 lux

PowerScan® PD8530™

Optical Features			
Focus distance	140 mm		
Field of view	28° (H) x 23° (V)		
Horizontal field of view at distance (d) in mm	0.52d + 15		
Vertical field of view at distance (d) in mm	0.42d + 12		
Max Resolution	Linear codes - mm (mils)	PDF 417 – mm (mils)	Datamatrix – mm (mils)
	0.10 (4 mils)	0.10 (4 mils)	0.17 (6.6 mils)
Depth of field*			
1D (linear):	X-dimension mm (mils)	DOF cm (in)	
Code39	0.13 (5)	7.5 to 15.5 (2.95 to 6.10)	
	0.5 (20)	5.5 to 36.5 (2.17 to 14.37)	
EAN13	0.33 (13)	5.0 to 27 (1.97 to 10.63)	
2D:	X-dimension mm (mils)	DOF cm (in)	
PDF417	0.13 (5)	8.0 to 18.5 (3.15 to 7.28)	
	0.25 (10)	4.0 to 25.5 (1.57 to 10.04)	
QR	0.19 (7.5)	8.0 to 16.5 (3.15 to 6.5)	
	0.25 (10)	7.0 to 19.5 (2.76 to 7.68)	
DataMatrix	0.19 (7.5)	8.0 to 16.5 (3.15 to 6.5)	
	0.25 (10)	7.0 to 19.5 (2.76 to 7.68)	
Skew	±40°		
Pitch	±35°		
Rotation	360°		
Print Contrast (Min.)	15%		

* Reading distances are measured from the nose of the reader.

NOTE: Typical performance at 20°C / 68°F on high quality barcodes.

PowerScan® PD8530™ HD

Optical Features			
Focus distance	65 mm		
Field of view	27° (H) x 22° (V)		
Horizontal field of view at distance (d) in mm	0.50d + 13		
Vertical field of view at distance (d) in mm	0.40d + 10		
Max Resolution	Linear codes - mm (mils)	PDF 417 – mm (mils)	Datamatrix – mm (mils)
	0.05 (2 mils)	0.08 (3 mils)	0.10 (4 mils)
Depth of field*			
1D (linear):	X-dimension mm (mils)	DOF cm (in)	
Code39	0.08 (3)	4.5 to 8.0 (1.77 to 3.15)	
	0.13 (5)	3.5 to 9.5 (1.38 to 3.74)	
	0.51 (20)	6.0 to 18.5 (2.36 to 7.28)	
EAN13	0.33 (13)	5.0 to 14 (1.97 to 5.51)	
2D:	X-dimension mm (mils)	DOF cm (in)	
PDF417	0.08 (3)	5.0 to 8.5 (1.97 to 3.35)	
	0.13 (5)	4.5 to 9.5 (1.77 to 3.74)	
	0.25 (10)	3.0 to 13.0 (1.18 to 5.12)	
QR	0.10 (4)	5.5 to 7.5 (2.17 to 2.95)	
	0.19 (7.5)	5.0 to 8.0 (1.97 to 3.15)	
	0.25 (10)	4.5 to 9.5 (1.77 to 3.74)	
DATAMATRIX	0.10 (4)	5.5 to 7.5 (2.17 to 2.95)	
	0.19 (7.5)	5.0 to 8.0 (1.97 to 3.15)	
	0.25 (10)	4.5 to 9.5 (1.77 to 3.74)	
Skew	±40°		
Pitch	±35°		
Rotation	360°		
Print Contrast (Min.)	23%		

- Reading distances are measured from the nose of the reader.

NOTE: Typical performance at 20°C / 68°F on high quality barcodes.

PowerScan® PD8530™ WA

Optical Features			
Focus distance	115 mm		
Field of view	54° (H) x 45° (V)		
Horizontal field of view at distance (d) in mm	1.04d + 40		
Vertical field of view at distance (d) in mm	0.40d + 10		
Max Resolution	Linear codes - mm (mils)	PDF 417 – mm (mils)	Datamatrix – mm (mils)
	0.13 (5 mils)	0.13 (5 mils)	0.19 (7.5 mils)
Depth of field*			
1D (linear):	X-dimension mm (mils)	DOF cm (in)	
Code39	0.13 (5)	2.5 to 10.0 (0.98 to 3.94)	
	0.51 (20)	1.5 to 32 (0.59 to 12.60)	
EAN 13	0.33 (13)	1.5 to 26.0 (0.59 to 10.24)	
2D:	X-dimension mm (mils)	DOF cm (in)	
PDF417	0.13 (5)	3.0 to 10.5 (1.18 to 4.13)	
	0.25 (10)	1.5 to 21.5 (0.59 to 8.46)	
QR	0.19 (7.5)	5.5 to 8.5 (2.17 to 3.35)	
	0.25 (10)	3.0 to 12.5 (1.18 to 4.92)	
DataMatrix	0.19 (7.5)	5.5 to 8.5 (2.17 to 3.35)	
	0.25 (10)	3.0 to 12.5 (1.18 to 4.92)	
Skew	±40°		
Pitch	±35°		
Rotation	360°		
Print Contrast (Min.)	15%		

- Reading distances are measured from the nose of the reader.

NOTE: Typical performance at 20°C / 68°F on high quality barcodes.

8.1 INDICATORS

8.1.1 PowerScan® PD8530 LED Indicators

The PowerScan® PD8530 family uses green LED indicators to signal the following reader functions:

STATUS	BEHAVIOR
Power ON	At power-on, the LEDs blink briefly, then light up for 2 seconds to signal the power supply is present.
Normal Function	The LED lights up after a good decoding and will switch off only at the next trigger press.

8.1.2 Beeper

The PowerScan® PD8530 basic software provides beeper signals for good/wrong reading and for indicating errors. Its tone, volume and duration can be directly configured by using the codes given in the PowerScan® PD8530 Reference Manual available on the website.

The application program can also manage the beeper (User Defined Beeper) when the reader is controlled by a Host PC. It is possible to activate the beeper by sending a command from the Host to the reader via the current communication interface.

8.1.3 Good Read Spot

A green Good-Read Spot will be projected in the field of view when the reading is successful.

A HOST CONFIGURATION STRINGS

In this section we provide a description of how to modify the device configuration using serial strings sent from the Host.

This method requires the RS-232, USB-Com, USB Bulk or USB Generic HID interface.

The device configuration can be changed by receiving commands from the Host through the current interface. When this method is used, the programming sequence format is the following:

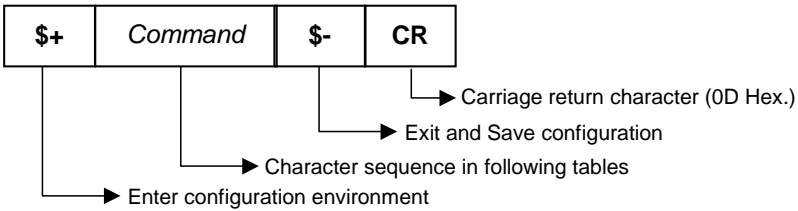

Example:

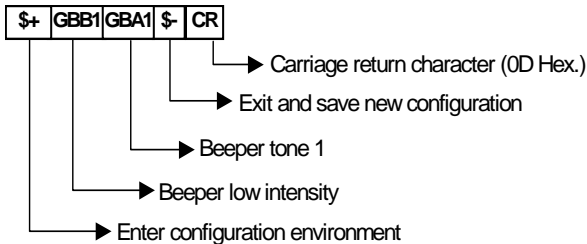

Each configuration parameter setting removes the condition previously active for that parameter.



NOTE

Configuring some configuration commands through strings, such as advanced formatting, may be very complex. For this reason they are not provided in the following tables but can be configured by using Datalogic Aladdin™ configuration program or referring to the related section in chapter 4 of this manual.

SERIAL CONFIGURATION STRINGS

ENTER/EXIT CONFIGURATION COMMANDS	
DESCRIPTION	STRING
Enter Configuration	\$+
Exit and Save Configuration	\$-
Restore Default	\$\$* [†]
Transmit Software Release	\$\$#!
Transmit Device Configuration in ASCII	\$\$?&
Save Custom Default	\$\$+\$0
Restore Custom Default	\$\$+\$1

These commands do not require \$-

INTERFACE SELECTION		
DESCRIPTION		STRING
RS-232	Standard	CPA0
WEDGE	for IBM AT	CPA1
USB	USB COM	CPA3
	USB-KBD	CPA4
	USB Bulk	CPA2
	USB Generic HID	CPA5
	USB IBM	CPA7

RS-232		
DESCRIPTION		STRING
Baud rate	1200	DAA00
	2400	DAA01
	4800	DAA02
	9600	DAA03
	14400	DAA04
	19200	DAA05
	38400	DAA06
	57600	DAA07
Parity	115200	DAA08
	none	DBA0
	even	DBA2
Data bits	odd	DBA1
	7	DCA0
	8	DCA1
Stop bits	1	DCB0
	2	DCB1
Handshake	none	DDA0
	RTS/CTS	DDA2
	XON/XOFF	DDA1
	RTS always ON	DDA3
ACK/NACK Protocol	disabled	DDB0
	enabled	DDB1

RS-232 (continued)		
DESCRIPTION		STRING
FIFO	disabled	DDC0
	enabled	DDC1
RX Timeout		DEB00 - DEB99
Intercharacter Delay		DEA00 - DEA99
Intercode Delay		DEC00 - DEC99
Serial Trigger Lock	disabled	DDB0
	enabled	DDB1
	Serial trigger Lock/Unlock characters	CQBxx

x = Hex value from **00** to **FF**

USB		
DESCRIPTION		STRING
USB-COM		
Handshake	none	UDA0
	RTS/CTS	UDA2
	XON/XOFF	UDA1
ACK/NACK Protocol	disabled	UDB0
	enabled	UDB1
FIFO	disabled	UDC0
	enabled	UDC1
RX Timeout		DEB00 - DEB99
Intercharacter Delay		UEA00 - UEA99
Intercode Delay		UEC00 - UEC99
IBM USB		
Device Usage	Table top	UJA0
	Handheld	UJA1

DATA FORMAT		
DESCRIPTION		STRING
Data Format Restore Default		EZ0
SYMBOLOLOGY INDEPENDENT PARAMETERS		
Code Identifier	disabled	EAA0
	AIM standard Code ID	EAA2
	Custom Code ID	EAA1
	Datalogic Code ID	EAA3
Code Length	disabled	ECA0
	enabled	ECA1
Set Headers	no header	EDA00

DATA FORMAT (continued)		
DESCRIPTION		STRING
	one character	EDA01x
	two characters	EDA02xx
	three characters	EDA03xxx
	four characters	EDA04xxxx
	five characters	EDA05xxxxx
	six characters	EDA06xxxxxx
	seven characters	EDA07xxxxxxx
	eight characters	EDA08xxxxxxxxx
Set Headers	nine characters	EDA09xxxxxxxxxx
	ten characters	EDA10xxxxxxxxxxx
Headers	disabled	EDB0
	enabled	EDB1
Set Terminators	no terminator	EEA00
	one character	EEA01x
	two characters	EEA02xx
	three characters	EEA03xxx
	four characters	EEA04xxxx
	five characters	EEA05xxxxx
	six characters	EEA06xxxxxx
	seven characters	EEA07xxxxxxx
	eight characters	EEA08xxxxxxxxx
	nine characters	EEA09xxxxxxxxxx
Terminators	ten characters	EEA10xxxxxxxxxxx
	disabled	EEB0
	enabled	EEB1

x, a = HEX values representing an ASCII character.

x = Hex value from **00** to **FF**

CAMERA CONTROL		
DESCRIPTION		STRING
Exposure Mode	automatic (entire image)	FFA1
	automatic (central part of image)	FFA2
	automatic for highly reflective surfaces	FFA3

POWER SAVE		
DESCRIPTION		STRING
Illumination System Power	Illumination System OFF	HAA0
	Illumination System ON	HAA1

CODE SELECTION			
DESCRIPTION		STRING	
Disable All Symbolologies		AZA0	
Disable All Linear Symbolologies		AXA0	
Disable All 2D Symbolologies		AYA0	
Issue Identical Codes	disabled	AWB0	
	enabled	AWB1	
LINEAR SYMBOLOGIES			
UPC/EAN/JAN	disabled	AEA0	
	enabled	AEA1	
	Add-on	disabled	AEB0
		enabled	AEB1
	UPCE extension	enabled	AEC0
		disabled	AEC1
Code 39	Standard	disabled	ABA0
		no ckeck digit control	ABA1
		ckeck digit control without transmission	ABA2
		ckeck digit control and transmission	ABA3
	Full ASCII	disabled	ABB0
		enabled	ABB1
	Code Len Check	disabled	ABC0
		enabled	ABC1
	Minimum Code Length		ABD <i>d</i>
	Maximum Code Length		ABE <i>d</i>
	Start/Stop Char TX	enabled	ABF0
		disabled	ABF1
	Code 32	disabled	ABL0
enabled		ABL1	

d = a number from the HEX/Numeric Table

d = a number in the range 001-255

CODE SELECTION			STRING
DESCRIPTION			STRING
LINEAR SYMBOLOGIES			
Interleaved 2/5	disabled		ACA0
	enabled – no check digit control		ACA1
	enabled – check digit control and without transmission		ACA2
	enabled – check digit control and transmission		ACA3
	Code Len Check	disabled	ACB0
		enabled	ACB1
	Minimum Code Length		ACCd
	Maximum Code Length		ACDd
Codabar	disabled		ADA0
	enabled – no check digit control		ADA1
	enabled – check digit control and without transmission		ADA2
	enabled – check digit control and transmission		ADA3
	Code Len Check	disabled	ADB0
		enabled	ADB1
	Minimum Code Length		ADCd
	Maximum Code Length		ADDd
Code 128	disabled		AAA0
	enabled		AAA1
	Code Len Check	disabled	AAB0
		enabled	AAB1
	Minimum Code Length		AACd
	Maximum Code Length		AADd
EAN 128	disabled		AOA0
	enabled		AOA1
	Code Len Check	disabled	AOB0
		enabled	AOB1
	Minimum Code Length		AOCd
	Maximum Code Length		AODd
Code 93	disabled		AFA0
	enabled		AFA1
	Code Len Check	disabled	AFB0
		enabled	AFB1
	Minimum Code Length		AFCd
	Maximum Code Length		AFDd
GS1 DataBar™ Family	GS1 DataBar Expanded	disabled	AMA0
		enabled	AMA1
	GS1 DataBar Limited	disabled	AMB0
		enabled	AMB1
	GS1 DataBar Omnidirectional	disabled	AMC0
		enabled	AMC1

CODE SELECTION (continued)			STRING
DESCRIPTION			
	GS1 DataBar Expanded	disabled	AMD0
	Stacked	enabled	AMD1
	GS1 DataBar Stacked	disabled	AME0
		enabled	AME1

d = a number from the HEX/Numeric Table

d = a number in the range 001-255

CODE SELECTION			STRING
DESCRIPTION			
2D SYMBOLOGIES			
PDF417	disabled		AGA0
	enabled		AGA1
	Macro PDF417	unbuffered mode	AVB0
		buffered mode	AVB1
	Micro PDF417	disabled	AGB0
		enabled	AGB1
DataMatrix	disabled		AHA0
	enabled		AHA1
	Minimum Code Length		AHCe
	Maximum Code Length		AHDe
	Rectangular Style	disabled	AHE0
		enabled	AHE1
QR Family	disabled		AIA0
	enabled		AIA1
Postal Codes	all disabled		ALA0
	Australian Post - enabled		ALA1
	Japan Post - enabled		ALA2
	PLANET - enabled		ALA3
	POSTNET - enabled		ALA4
	POSTNET with B and B' - enabled		ALA5
	POSTNET and PLANET - enabled		ALA6
	POSTNET with B and B' and PLANET - enabled		ALA7
	KIX Code - enabled		ALA8
	Royal Mail Code (RM4SCC) - enabled		ALA9
Australian Table	N Table		ALB0
	C Table		ALB1
Maxicode	Mode 0	disabled	AJL0
		enabled	AJL1
	Mode 1	disabled	AJM0
		enabled	AJM1
	Mode 2	disabled	AJN0
		enabled	AJN1
	Mode 3	disabled	AJO0
		enabled	AJO1
	Mode 4	disabled	AJP0
		enabled	AJP1
	Mode 5	disabled	AJQ0
		enabled	AJQ1
	Mode 6	disabled	AJR0
		enabled	AJR1
Aztec	disabled		AKA0
	enabled		AKA2

CODE SELECTION (continued)			
DESCRIPTION		STRING	
Composite Code	disabled		ANA0
	enabled		ANA1
	Discard Linear Part	disabled	ANB0
		enabled	ANB1

e = a number from the HEX/Numeric Table

e = a number in the range 0001-3600

READING PARAMETERS		
DESCRIPTION		STRING
Trigger Mode	trigger level	BAA0
	trigger pulse	BAA1
Trigger Type	normal trigger	BAB0
	software trigger	BAB1
Flash On Duration		BF0f
Flash Off Duration		BF1f
Beeper Tone	tone 1	GBA1
	tone 2	GBA2
	tone 3	GBA3
	tone 4	GBA4
Beeper Volume	off	GBB0
	low	GBB1
	medium	GBB2
	high	GBB3
Beeper Duration		GBCf
Reads per Cycle	one read per cycle	BCA0
	multiple reads per cycle	BCA1
Scan Timeout		BEAf
User Defined Beeper Tone	tone 1	GBD1
	tone 2	GBD2
	tone 3	GBD3
	tone 4	GBD4
User Defined Beeper Volume	off	GBE0
	low	GBE1
	medium	GBE2
	high	GBE3
User Defined Beeper Duration		GBFf
Perform User Defined Beep**		\$?GGG

** this command carries out its specific function and does not need \$+ and \$-.

CODE ORDERING AND SELECTION		
Code per Scan	one code per scan	BCB0
	all codes per scan	BCB1
Central Code Transmission	disabled	OAA0
	enabled	OAA1
Order by Code Length	disabled	OAB0
	enabled - increasing order	OAB1
	enabled - decreasing order	OAB2

f = a number from the HEX/Numeric Table

f = a number in the range 01-99

READING PARAMETERS		
DESCRIPTION		STRING
AUTOSCAN		
Autoscan Mode	disabled	BBA0
	enabled in normal mode	BBA1
	enabled in pattern mode	BBA2
Autoscan Aiming System	disabled	BBB0
	enabled	BBB1
Autoscan Hardware Trigger	disabled	BBC0
	enabled	BBC1
Autoscan Illumination System	disabled	BBD0
	enabled	BBD1
Safety Time	disabled	BGA0
	enabled	BGA1
Safety Time Duration		BGBf

f = a number from the HEX/Numeric Table

f = a number in the range 01-99

ADVANCED IMAGE CAPTURE		
DESCRIPTION		STRING
IMAGE PRESET 1		
Basic Configuration		
Image Format	JPEG format	IAA1
	TIFF format	IAA2
Resolution	full resolution (1280 x 1024)	IAB0
	half resolution (640 x 512)	IAB1
JPEG Quality Factor		IACg

g = a number from the HEX/Numeric Table

g = a number in the range 000-100

ADVANCED IMAGE CAPTURE		
DESCRIPTION		STRING
IMAGE PRESET 1		
Advanced Configuration		
Brightness	increase	IAO0IAF<i>i</i>
	decrease	IAO1IAF1<i>i</i>
Contrast	increase	IAP0IAE<i>i</i>
	decrease	IAP1IAE<i>i</i>
Color Depth	2 gray levels	IAG0
	16 gray levels	IAG1
	256 gray levels	IAG2

i = a number from the HEX/Numeric Table

i = a number in the range 0-100

ADVANCED IMAGE CAPTURE		
DESCRIPTION		STRING
IMAGE PRESET 2		
Basic Configuration		
Image Format	JPEG format	IBA1
	TIFF format	IBA2
Resolution	full resolution (1280 x 1024)	IBB0
	half resolution (640 x 512)	IBB1
JPEG Quality Factor		IBC<i>g</i>
Advanced Configuration		
Brightness	increase	IBO0IBF<i>i</i>
	decrease	IBO1IBF1<i>i</i>
Contrast	increase	IBP0IBE<i>i</i>
	decrease	IBP1IBE<i>i</i>
Color Depth	2 gray levels	IBG0
	16 gray levels	IBG1
	256 gray levels	IBG2

g, i = a number from the HEX/Numeric Table

g = a number in the range 000-100

i = a number in the range 0-100

ADVANCED IMAGE CAPTURE		
DESCRIPTION		STRING
IMAGE PRESET 3		
Basic Configuration		
Image Format	JPEG format	ICA1
	TIFF format	ICA2
Resolution	full resolution (1280 x 1024)	ICB0
	half resolution (640 x 512)	ICB1
JPEG Quality Factor		ICGg
Advanced Configuration		
Brightness	increase	ICO0ICFi
	decrease	ICO1ICFi
Contrast	increase	ICP0ICEi
	decrease	ICP1ICEi
Color Depth	2 gray levels	ICG0
	16 gray levels	ICG1
	256 gray levels	ICG2

g, i = a number from the HEX/Numeric Table

g = a number in the range 000-100

i = a number in the range 0-100

ADVANCED IMAGE CAPTURE		
DESCRIPTION		STRING
IMAGE PRESET 4		
Basic Configuration		
Image Format	JPEG format	IDA1
	TIFF format	IDA2
Resolution	full resolution (1280 x 1024)	IDB0
	half resolution (640 x 512)	IDB1
JPEG Quality Factor		IDCg
Advanced Configuration		
Brightness	increase	IDO0IDFi
	decrease	IDO1IDFi
Contrast	increase	IDP0IDEi
	decrease	IDP1IDEi
Color Depth	2 gray levels	IDG0
	16 gray levels	IDG1
	256 gray levels	IDG2

g, i = a number from the HEX/Numeric Table

g = a number in the range 000-100

i = a number in the range 0-100

B PROGRAMMING FOR EXPERT USERS

This document is addressed to expert users who are familiar with software programming languages and want to define a personalized code formatting. The provided programming language allows creating either simple or complex formatting expressions by means of the basic functions connected together through the following operators: (,) , - , + .

The syntax to be used to transmit the expressions to the PowerScan® PD8530 is the following:

\$+ELB<n>formatting expression<ETX>\$-

where:

- <n> is a number in the range 1-5 corresponding to the format to be defined;
- <ETX> is the conventional character used as terminator of the command;
- the formatting expression uses ASCII characters when containing text strings. For this reason, the string must be inserted between two quotation marks. The following example shows the ASCII conversion of the "ABC" string:

`$+ELB1"414243"+#DS^C$-`

FUNCTION DESCRIPTION

All the functions and conventions to be used within the formatting expressions are listed below:

FUNCTION NAME	DESCRIPTION
FSTR	Searches for a defined substring by its starting and ending string.
FLSTR	Searches for a defined substring by its starting string and its length.
SSTR	Extracts a defined substring from the original string.
FPOS	Searches for a position of a defined substring within the original string.
LSTR	Returns a string length.
ISTR	Insert a substring in the original string.
RSTR	Substitutes a defined substring contained in the original string with a new one.

CONVENTIONS	DESCRIPTION
+	Concatenates two strings or fields.
-	Deletes a substring or a field from the original string.
#DS	Returns the string which has been decoded by the library.
#F<n>	Returns the result of a format which has been previously defined. The <n> value is in the range 1-4.

FindStringByStarting&EndingChar (FSTR)

This function has the following syntax:

FSTR<source_string, string_start, string_stop, mode>⇒string

This function searches for a substring having a defined starting character ("string_start") and a defined ending character ("string_stop") within the "source_string". It returns the string you searched for, or an empty one in case of failure.

If searching for a substring having characters already known, the "string_start" and "string_stop" arguments must share the same value.

The "mode" argument allows managing the starting character ("string_start") and the ending character ("string_stop"):

- 0 = include both starting and ending character
- 1 = include only starting character
- 2 = include only ending character
- 3 = discard both starting and ending character

FindStringByStartingChar&Len (FLSTR)

This function has the following syntax:

FLSTR<source_string, string_start, len, mode>⇒string

This function searches for a substring having a defined starting character ("string_start") and a defined length ("len") within the "source_string". It returns the string you searched for, or an empty one in case of failure.

If searching for a substring having a length already known, the "string_start" and "string_stop" arguments must share the same number.

The "mode" argument allows managing the starting character ("string_start"):

- 0 = include starting character
- 1 = discard starting character

SelectString (SSTR)

This function has the following syntax:

SSTR<source_string, pos_start, pos_end>⇒string

It extracts a substring whose characters are between "pos_start" and "pos_end" from the "source_string".

If "pos_end" is longer than the "source_string" length, no error will be generated since the exceeding characters are ignored.

The first character of every string is in position 1.

FindPosition (FPOS)

This function has the following syntax:

FPOS<source_string, search_string>⇒position

This function searches for a defined substring within the "source_string" and returns its position. If the substring is not found, the returned value is 1.

StringLength (LSTR)

This function has the following syntax:

LSTR<string>⇒length

This function returns the length of the defined string.

StringConcatenation

This function has the following syntax:

string1 + string2⇒string

This function allows concatenating two different strings in order to get a single string as result.

StringDiscard

This function has the following syntax:

```
string1 - string2⇒string
```

This function discards all the strings having the same value as "string2" which can be found in "string1". If no "string2" is found within "string1", the result returns "string1".

InsertString (ISTR)

This function has the following syntax:

```
ISTR<source_string, string1, position>⇒string
```

This function inserts a new string ("string1") within the "source_string" and places it in the defined "position".

If the value of the "position" argument is longer than "source_string" length, "string1" will be placed after the last character of the source string.

ReplaceString (RSTR)

This function has the following syntax:

```
RSTR<source_string, string1, string2>⇒string
```

This function searches for "string1" within the "source_string". All the strings having the same value as "string1" within the "source_string" will be replaced by "string2".

If no "string1" is found in the "source_string", the result returns the "source_string".

Examples

The string transmitted is "12345abcdef3790" and corresponds to the #DS function, as defined in the programming language.

- 1) expression ⇒ **SSTR<#DS,1,5> + SSTR<#DS,11,15> + SSTR<#DS,6,9>**
result ⇒ **"12345f3790abcd"**
- 2) expression ⇒ **FSTR<#DS, "616263", "616263", 0> + SSTR<#DS,LSTR<#DS>-3, LSTR<#DS>**
result ⇒ **"abc3790"**
- 3) expression ⇒ **FSTR<#DS, "616272", "616261", 0>**
result ⇒ **" null string"**
- 4) expression ⇒ **#DS - FSTR<#DS, "616263", "6566", 0>**
result ⇒ **"123453790"**

During the format definition the decoded string represented by #DS does not change.

Using Format Output in Format Definition

The input used by the above functions to define the code formatting usually corresponds to the decoded code (#DS). Actually, the formatting expression of each function can also format the result (output) produced by a preceding code formatting. The format output is represented as follow:

#F<n>, where:

<n> = format number in the range 1-4

#F = format output

Being Format 5 not included in other format expression, the format number is in the range 1-4. Furthermore, since a format expression operates upon the output of the preceding formats, the expression defining Format 1 will never contain the result of another format.

Example

The following expression is used to define Format 3:

#DS + FSTR<#F2, "6173", "6263", 0>

The expression input consists of the decoded code and the result produced by Format 2 (#F2).

The FSTR function searches for a defined substring within the #F2 result; then, it concatenates this substring and the decoded code. The result corresponds to #F3 output.

C CODE IDENTIFIER TABLE

EAN/UPC



CODABAR



CODE 128



EAN 128



CODE 93



CODE 32



CODE 39



INTERLEAVED 2 OF 5



PDF417



MICRO PDF417



DATAMATRIX



MAXICODE



QR



AUSTRALIA POST



JAPAN POST



POSTNET



PLANET



GS1 DATABAR



KIX CODE



RM4SCC



AZTEC



D HEX AND NUMERIC TABLE

CHARACTER TO HEX CONVERSION TABLE								
char	decimal	hex	char	decimal	hex	char	decimal	hex
NUL	000	00	*	042	2A	U	085	55
SOH	001	01	+	043	2B	V	086	56
STX	002	02	,	044	2C	W	087	57
ETX	003	03	-	045	2D	X	088	58
EOT	004	04	.	046	2E	Y	089	59
ENQ	005	05	/	047	2F	Z	090	5A
ACK	006	06	0	048	30	[091	5B
BEL	007	07	1	049	31	\	092	5C
BS	008	08	2	050	32]	093	5D
HT	009	09	3	051	33	^	094	5E
LF	010	0A	4	052	34	~	095	5F
VT	011	0B	5	053	35	a	096	60
FF	012	0C	6	054	36	b	097	61
CR	013	0D	7	055	37	c	098	62
SO	014	0E	8	056	38	d	099	63
SI	015	0F	9	057	39	e	100	64
DLE	016	10	:	058	3A	f	101	65
DC1	017	11	;	059	3B	g	102	66
DC2	018	12	<	060	3C	h	103	67
DC3	019	13	=	061	3D	i	104	68
DC4	020	14	>	062	3E	j	105	69
NAK	021	15	?	063	3F	k	106	6A
SYN	022	16	@	064	40	l	107	6B
ETB	023	17	A	065	41	m	108	6C
CAN	024	18	B	066	42	n	109	6D
EM	025	19	C	067	43	o	110	6E
SUB	026	1A	D	068	44	p	111	6F
ESC	027	1B	E	069	45	q	112	70
FS	028	1C	F	070	46	r	113	71
GS	029	1D	G	071	47	s	114	72
RS	030	1E	H	072	48	t	115	73
US	031	1F	I	073	49	u	116	74
SPACE	032	20	J	074	4A	v	117	75
!	033	21	K	075	4B	w	118	76
"	034	22	L	076	4C	x	119	77
#	035	23	M	077	4D	y	120	78
\$	036	24	N	078	4E	z	121	79
%	037	25	O	079	4F	{	122	7A
&	038	26	P	080	50		123	7B
'	039	27	Q	081	51	}	124	7C
(040	28	R	082	52	~	125	7D
)	041	29	S	083	53	DEL	126	7E
			T	084	54		127	7F

0



1



2



3



4



5



6



7



8



9



A



B



C



D



E



F



AUTOSCAN PATTERN CODE

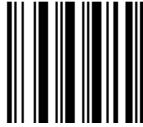

NOTES



Datalogic Scanning Group Srl
Via S. Vitalino, 13
Lippo di Calderara di Reno (BO)
40012 Italy

dichiara che
declares that the
déclare que le
bescheinigt ,daß das Gerät
declare que el

POWERSCAN PD8530 ; 2D Reader

e tutti i suoi modelli
and all its models
et tous les modèles
und seine modelle
y todos sus modelos

sono conformi alle Direttive del Consiglio Europeo sottoelencate:
are in conformity with the requirements of the European Council Directives listed below
sont conformes aux spécifications des Directives de l'Union Européenne ci-dessous:
den nachstehenden angeführten Direktiven des Europäischen Rats:
cumple con los requisitos de las Directivas del Consejo Europeo, según la lista siguiente:

89/336/EEC EMC Directive	e	92/31/EEC, 93/68 /EEC	emendamenti successivi
	and		further amendments
	et		ses successifs amendements
	und		späteren Abänderungen
	y		sucesivas enmiendas

Basate sulle legislazioni degli Stati membri in relazione alla compatibilità elettromagnetica ed alla sicurezza dei prodotti.

On the approximation of the laws of Member States relating to electromagnetic compatibility and product safety.

Basée sur la législation des Etats membres relative à la compatibilité électromagnétique et à la sécurité des produits.

Über die Annäherung der Gesetze der Mitgliedsstaaten in bezug auf elektromagnetische Verträglichkeit und Produktsicherheit entsprechen.

Basado en la aproximación de las leyes de los Países Miembros respecto a la compatibilidad electromagnética y las Medidas de seguridad relativas al producto.

Questa dichiarazione è basata sulla conformità dei prodotti alle norme seguenti:

This declaration is based upon compliance of the products to the following standards:

Cette déclaration repose sur la conformité des produits aux normes suivantes:

Diese Erklärung basiert darauf, daß das Produkt den folgenden Normen entspricht:

Esta declaración se basa en el cumplimiento de los productos con las siguientes normas:

EN 55022 (CLASS A ITE), AUGUST 1994:

AMENDMENT A1 (CLASS A ITE), OCTOBER 2000:

EN 61000-6-2, OCTOBER 2001:

LIMITS AND METHODS OF MEASUREMENTS OF RADIO
DISTURBANCE CHARACTERISTICS OF INFORMATION
TECHNOLOGY EQUIPMENT
ELECTROMAGNETIC COMPATIBILITY (EMC)
PART 6-2: GENERIC STANDARDS - IMMUNITY FOR
INDUSTRIAL ENVIRONMENTS

Lippo di Calderara, February 11th , 2008

Ruggero Cacioppo
Quality Assurance Manager

Australia

Datalogic Scanning Pty Ltd
Telephone: [61] (2) 9870 3200
australia.scanning@datalogic.com

France and Benelux

Datalogic Scanning Sarl
Telephone: [33].01.64.86.71.00
france.scanning@datalogic.com

Germany

Datalogic Scanning GmbH
Telephone: 49 (0) 61 51/93 58-0
germany.scanning@datalogic.com

India

Datalogic Scanning India
Telephone: 91- 22 - 64504739
india.scanning@datalogic.com

Italy

Datalogic Scanning SpA
Telephone: [39] (0) 39/62903.1
italy.scanning@datalogic.com

Japan

Datalogic Scanning KK
Telephone: 81 (0)3 3491 6761
japan.scanning@datalogic.com

Latin America

Datalogic Scanning, Inc
Telephone: (305) 591-3222
latinamerica.scanning@datalogic.com

Singapore

Datalogic Scanning Singapore PTE LTD
Telephone: (65) 6435-1311
singapore.scanning@datalogic.com

Spain and Portugal

Datalogic Scanning Sarl Sucursal en España
Telephone: 34 91 746 28 60
spain.scanning@datalogic.com

United Kingdom

Datalogic Scanning LTD
Telephone: 44 (0) 1923 809500
uk.scanning@datalogic.com



www.scanning.datalogic.com

Datalogic Scanning, Inc.

959 Terry Street
Eugene, OR 97402
Telephone: (541) 683-5700
Fax: (541) 345-7140

